

5

Magnetic anisotropy

Magnetization reversal in thin films and some relevant experimental methods

Today's plan

- Magnetocrystalline anisotropy
- Shape anisotropy
- Surface anisotropy
- Stress anisotropy

Anisotropy of hysteresis – hysteresis of a sphere



Abbildung 4: Magnetisierungskurven von Einkristallen von (a) Fe nach Honda *et al.* [7], (b) Co nach Kaya [8] und (c) Ni nach Kaya [9]. Die leichten Achsen von Fe sind die $[100]$ Richtungen, für Ni die $[111]$ Richtungen und für Co die $[0001]$ Achse. Die leichten Richtungen sind dadurch ausgezeichnet, daß kleine Magnetfelder genügen um die Sättigungsmagnetisierung zu erreichen.

image source: S. Blügel, Magnetische Anisotropie und Magnetostriktion, Schriften des Forschungszentrums Jülich ISBN 3-89336-235-5, 1999

Anisotropy of hysteresis – hysteresis of a sphere

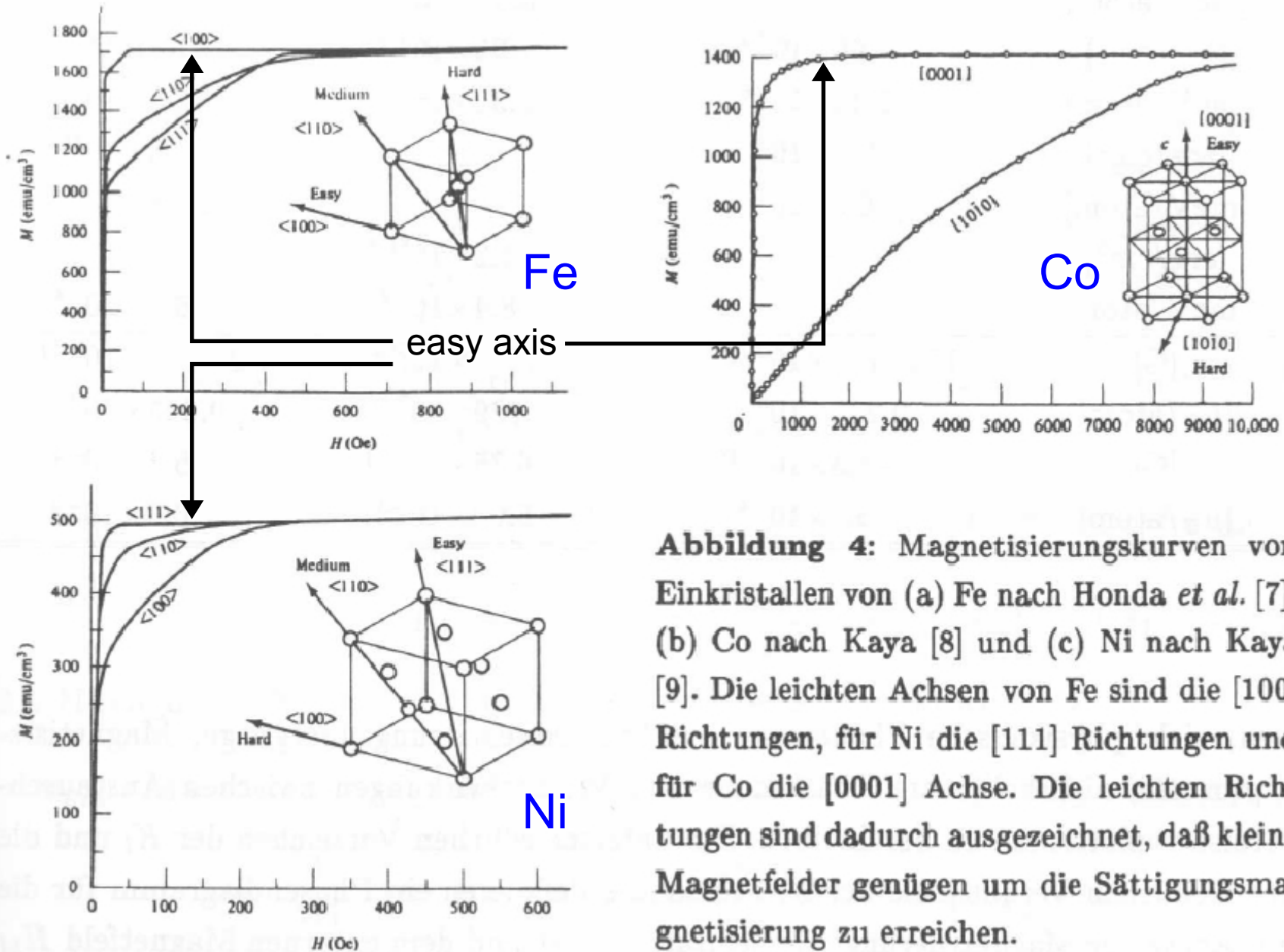

Abbildung 4: Magnetisierungskurven von Einkristallen von (a) Fe nach Honda *et al.* [7], (b) Co nach Kaya [8] und (c) Ni nach Kaya [9]. Die leichten Achsen von Fe sind die $[100]$ Richtungen, für Ni die $[111]$ Richtungen und für Co die $[0001]$ Achse. Die leichten Richtungen sind dadurch ausgezeichnet, dass kleine Magnetfelder genügen um die Sättigungsmagnetisierung zu erreichen.

- hard-axis reversal is characterized by higher field needed to saturate the sample
- the easy-axis reversal is usually characterized by higher hysteresis losses

image source: S. Blügel, Magnetische Anisotropie und Magnetostriktion, Schriften des Forschungszentrums Jülich ISBN 3-89336-235-5, 1999

Anisotropy of hysteresis

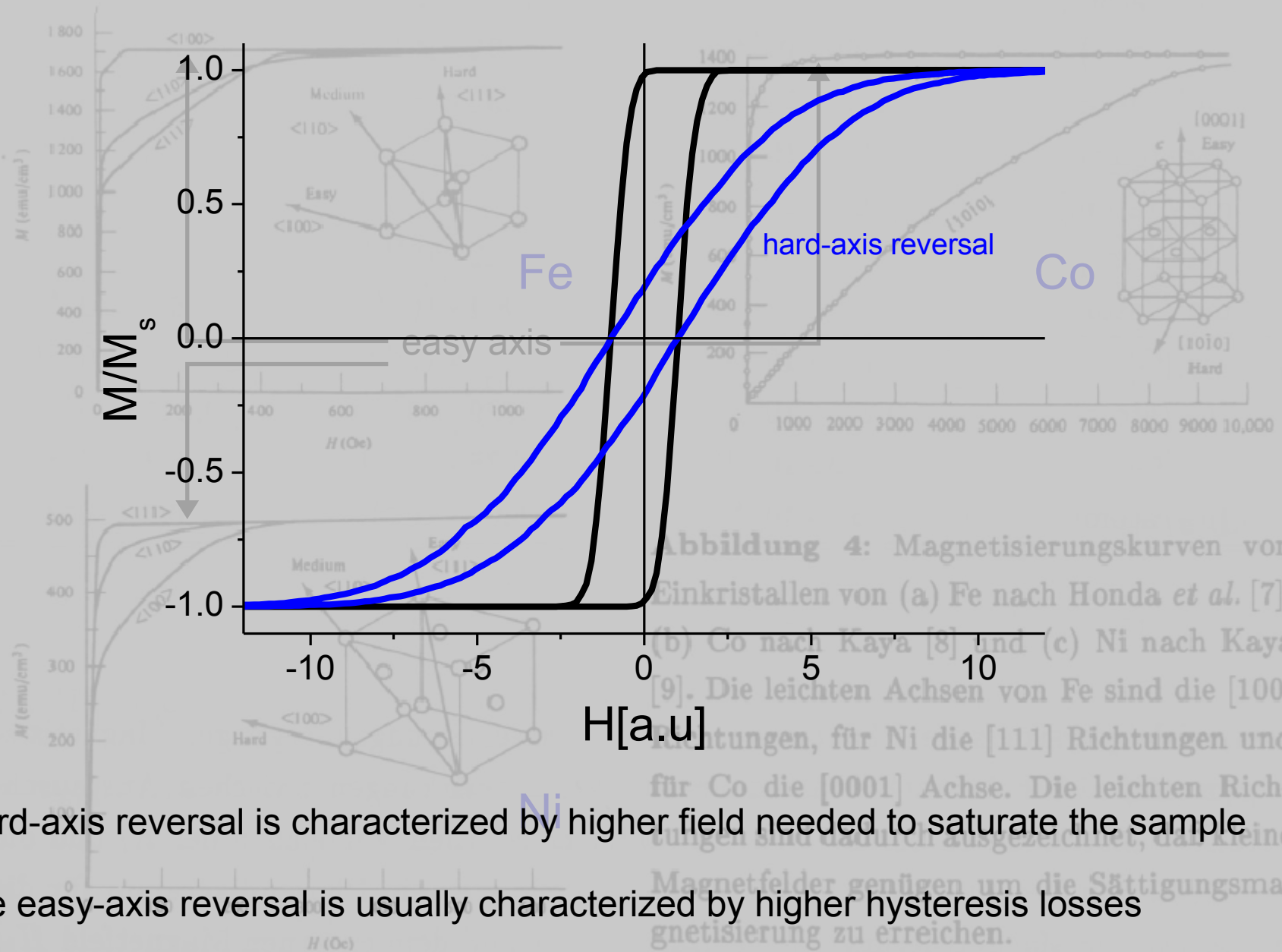
- In case of large sphere (containing many atoms) the shape of the sample does not introduce additional anisotropy
- In small clusters the magnetization reversal is complicated by the reduction of symmetry (and the increased relative contribution of surface atoms)

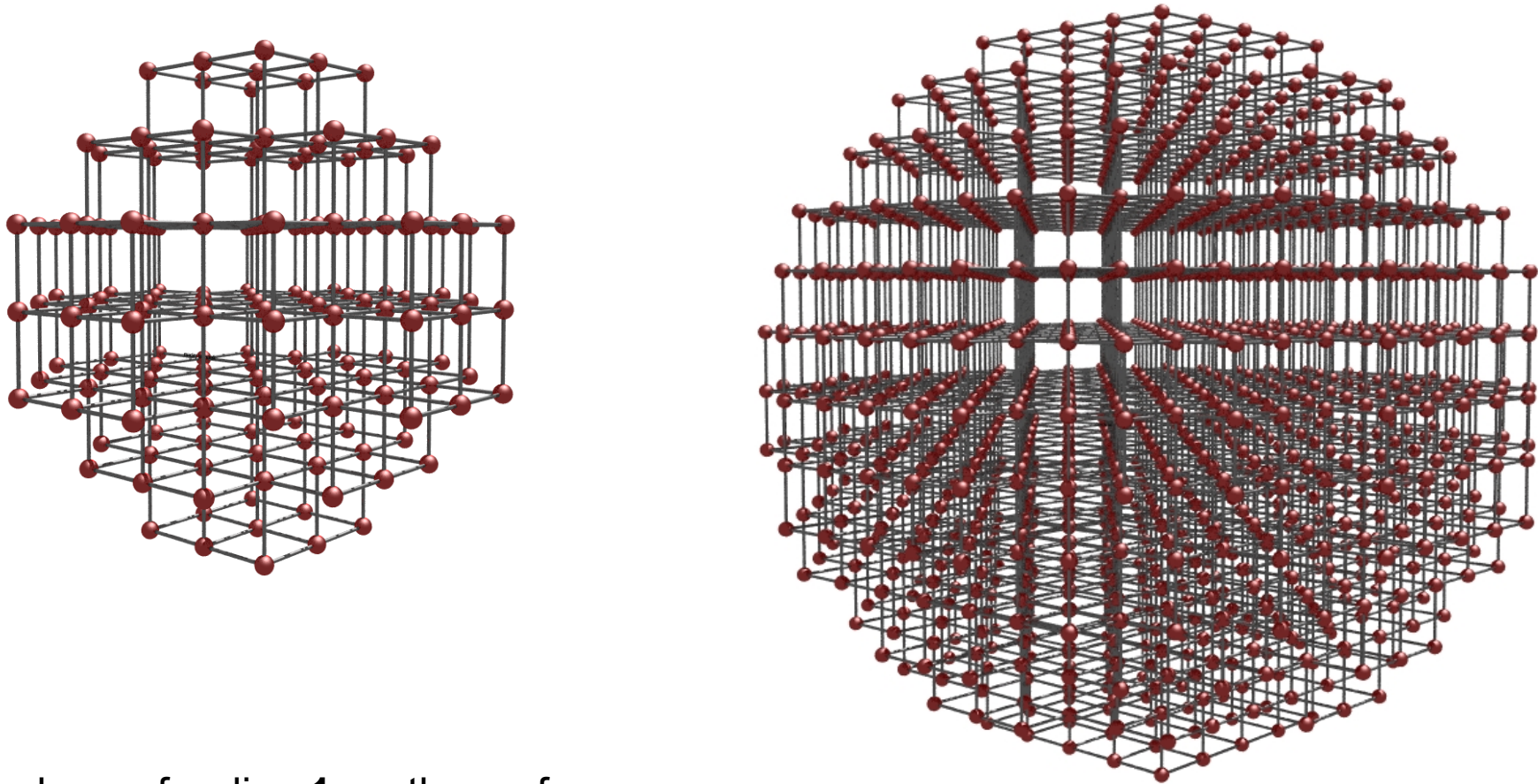

In Fe sphere of radius $1\mu\text{m}$ the surface atoms constitute roughly 0.04% of all atoms

Anisotropy of hysteresis

- In case of large sphere (containing many atoms) the shape of the sample does not introduce additional anisotropy
- In small clusters the magnetization reversal is complicated by the reduction of symmetry (and the increased relative contribution of surface atoms)

sphere-like – no breaking of crystal symmetry for high r

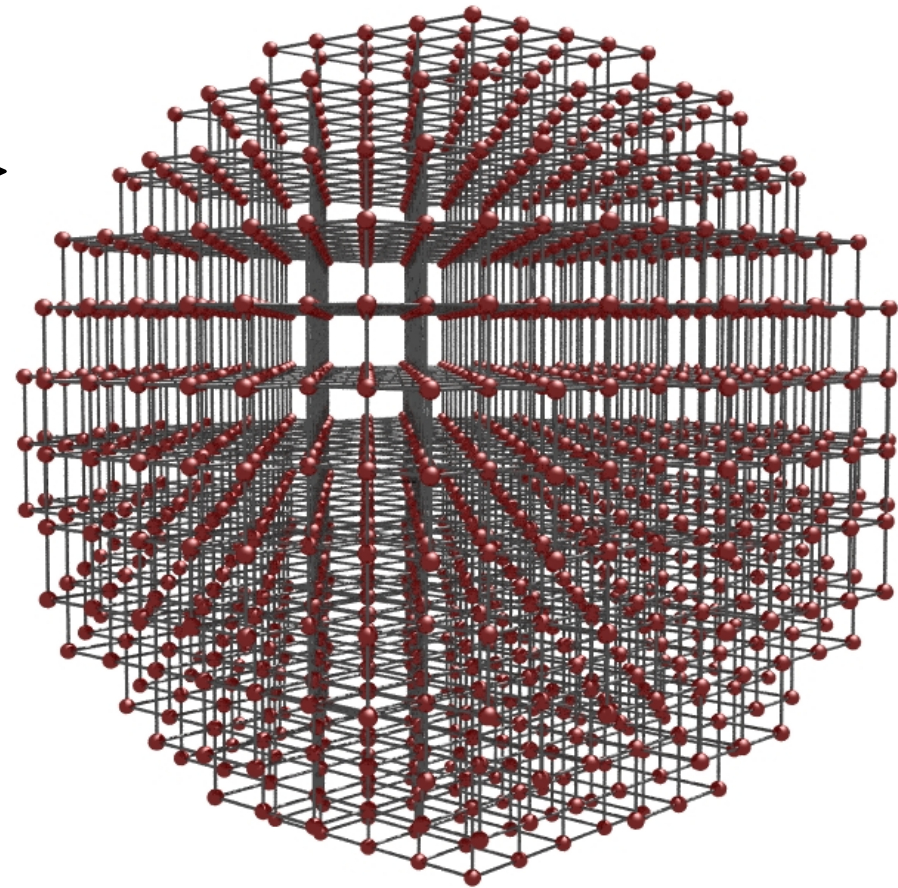
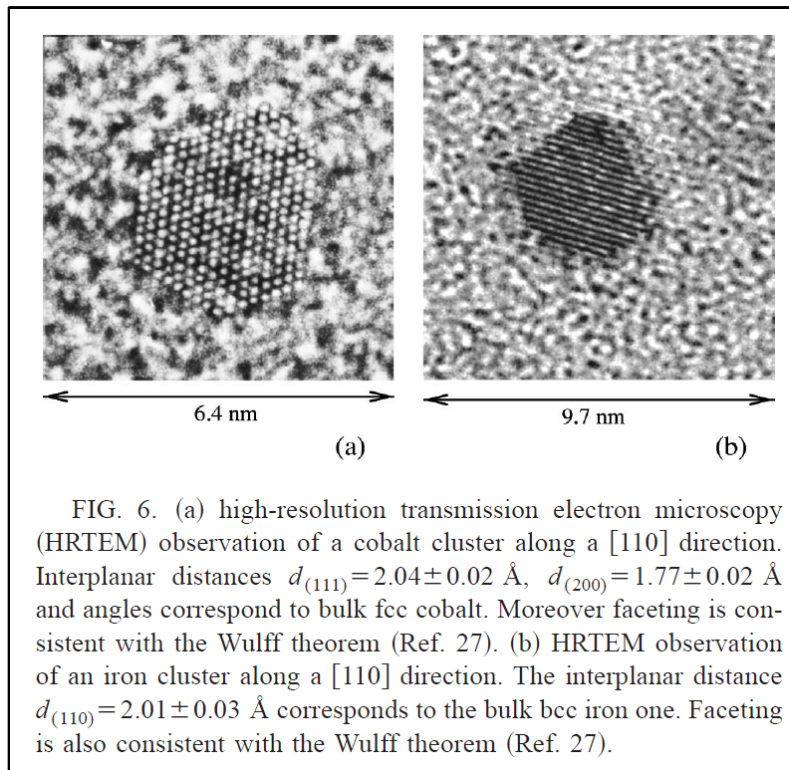

Anisotropy of hysteresis

Free magnetic moment in empty space (without the external field) – the energy does not depend on the orientation of the moment

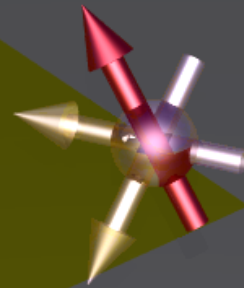

Anisotropy of hysteresis – single atoms on crystal surface

- Co atoms deposited by molecular beam epitaxy on Pt(111) surface
- Coverage less than 0.03 ML
- “The XMCD signal (Fig. 1C) is the difference between the XAS spectra recorded for parallel and antiparallel alignment of the photon helicity with the applied field \mathbf{B} . Fields of up to **7 T** were used to magnetize the sample at angles 0° and 70° with respect to the surface normal.”

- The presence of Pt surface induces very high magnetic anisotropy of 9.3 ± 1.6 meV/atom
- In SmCo5 magnets the anisotropy is 0.3 meV/Coatom

isolated Co adatoms

very high saturation field

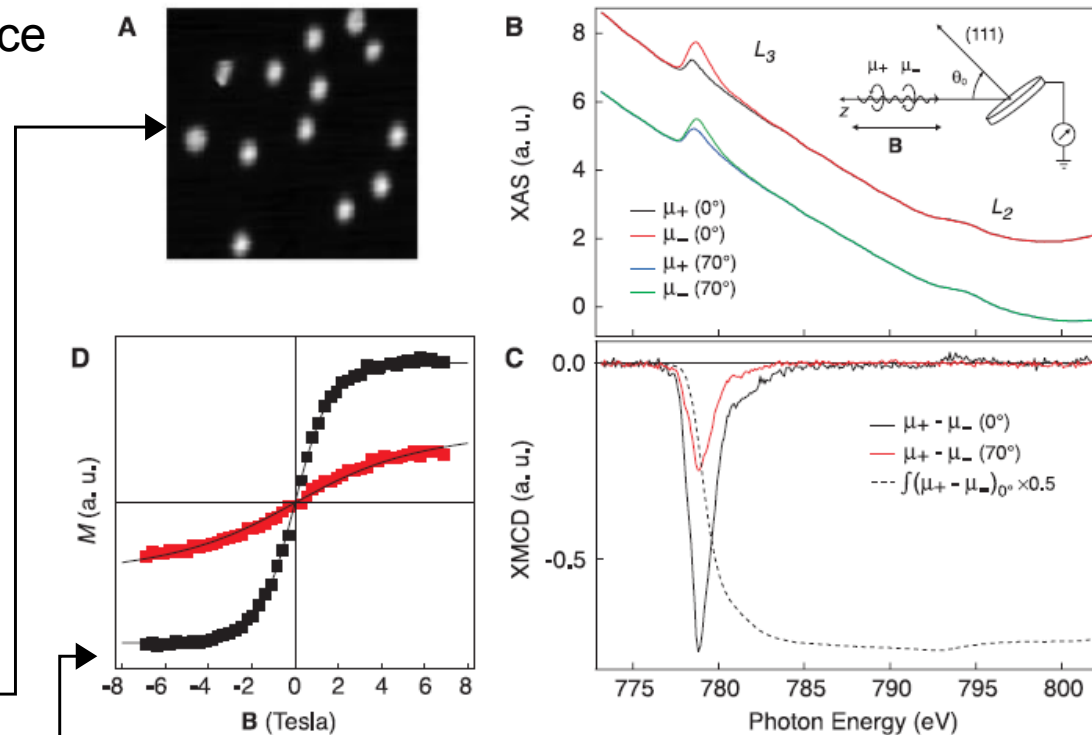
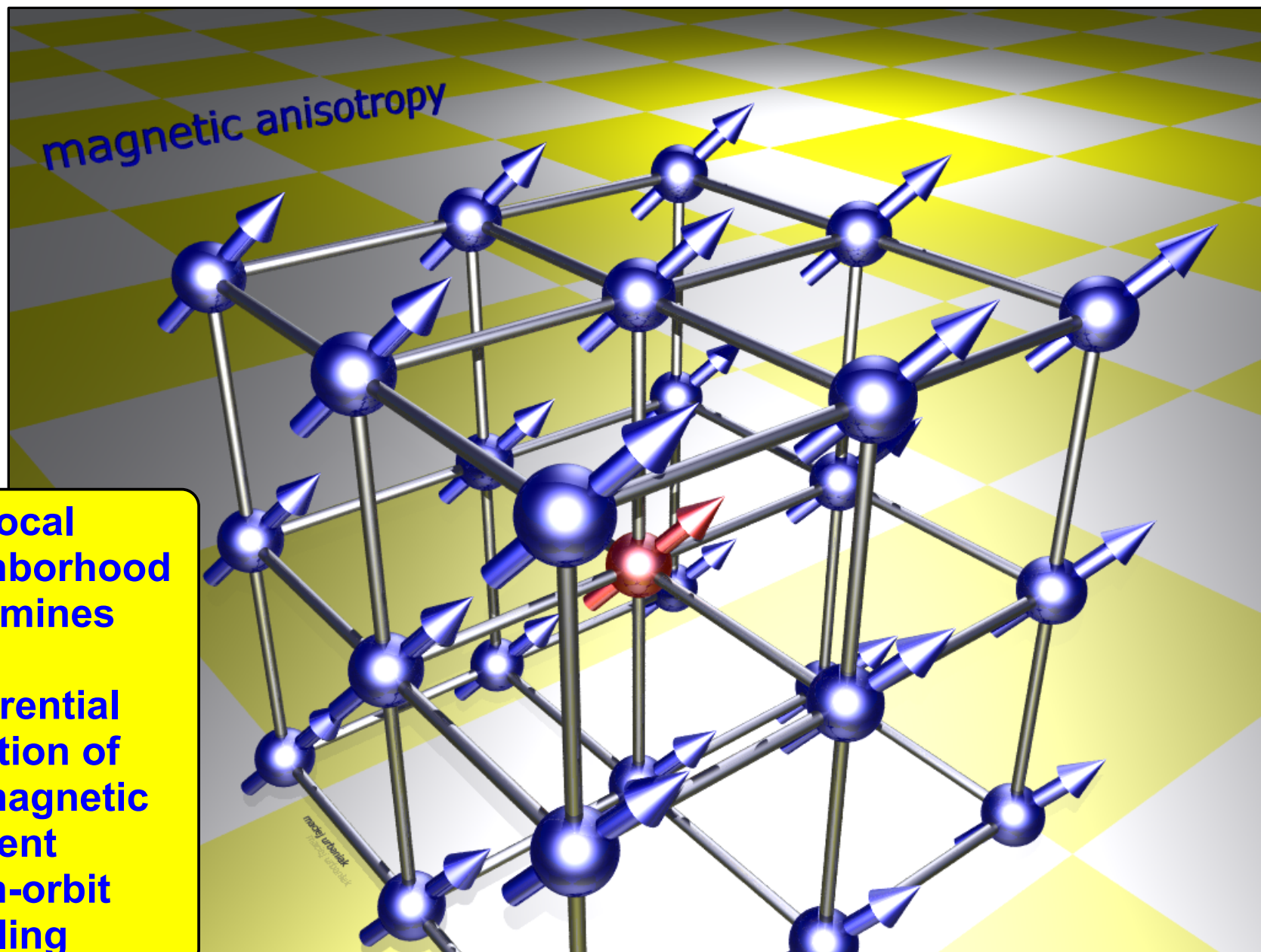

Fig. 1. (A) STM image of isolated Co adatoms (bright dots) on Pt(111). The Co coverage is 0.010 ML, and the image size is 85 Å by 85 Å. (B) $L_{2,3}$ XAS spectra of isolated Co adatoms (0.010 ML) at $T = 5.5 \pm 0.5$ K, $B = 7$ T taken with parallel (μ_+) and antiparallel (μ_-) alignment of light helicity with respect to \mathbf{B} at $\theta_0 = 0^\circ, 70^\circ$ relative to the surface normal (inset). The spectra at 70° have been normalized to the $(\mu_+ + \mu_-)$ L_3 intensity at 0° to eliminate the dependence of the electron yield on the sample orientation. (C) XMCD spectra ($\mu_+ - \mu_-$) obtained for the $\theta_0 = 0^\circ$ and 70° magnetization directions. The dashed line is the integrated XMCD at $\theta_0 = 0^\circ$. (D) Magnetization curves at $\theta_0 = 0^\circ$ (black squares) and 70° (red squares) measured at $T = 5.5$ K. The points represent the peak of the L_3 XMCD intensity at 778.6 eV divided by the pre-edge intensity at 775 eV as a function of B . The difference between the $\theta_0 = 0^\circ$ and 70° curves was checked for consistency with the XAS-normalized XMCD spectra. The solid lines are fits to the data according to Eq. 3.

P. Gambardella et al., Science **300**, 1130 (2003)

Anisotropy of hysteresis



Anisotropy of hysteresis

- For all practical purposes the atomic magnetic moments of a macroscopic homogeneous magnetic *sphere* behave as if placed in infinite crystal of the *same shape*.

A. Aharoni: "in ferromagnetism there is no physical meaning to the limit of an infinite *crystal without a surface*" [2]

- We do not know *a priori* the dependence of the energy of the crystal on the orientation of magnetic moment of the sample.
- It can be shown [1] that energy density related to the orientation of magnetic moment in a crystal structure can be expanded into power series of direction cosines relative to the crystal axes:

$$E_{crystal}(\vec{M}) = b_0 + \sum_{i=1,2,3} b_i \alpha_i + \sum_{i,j=1,2,3} b_{ij} \alpha_i \alpha_j + \sum_{i,j,k=1,2,3} b_{ijk} \alpha_i \alpha_j \alpha_k + \dots \quad (1)$$

$\alpha_1, \alpha_2, \alpha_3$ - direction cosines of magnetization

$(\alpha_1, \alpha_2, \alpha_3) = (\sin(\theta) \cos(\phi), \sin(\theta) \sin(\phi), \cos(\theta))$ θ, ϕ - polar and azimuthal angles

- The experience shows that it is enough to use very limited number of expansion terms to describe the magnetic systems – the usual limit are sixth order anisotropy constants

Anisotropy of hysteresis

- An example of the use of sixth order anisotropy constants for hysteresis description:

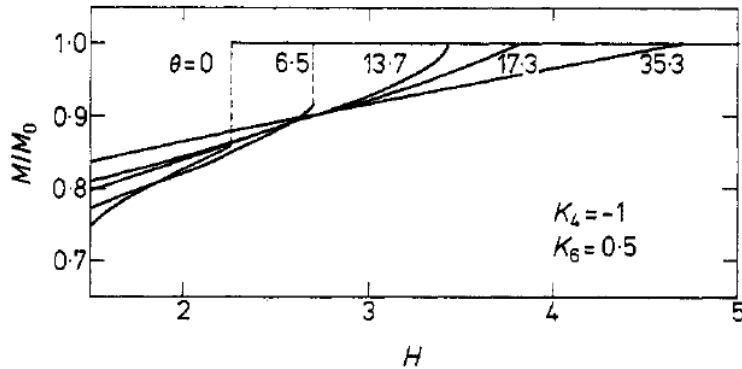

Figure 3. Magnetisation curves calculated for $\theta = 0^\circ, 6.5^\circ, 13.7^\circ (\simeq \theta_T), 17.3^\circ$ and 35.3° [110]. The parameters K_4 and K_6 are phenomenological and not directly related to DyAl_2 .

To see qualitatively that a sixth-order anisotropy term may indeed increase the discontinuity and the tricritical angle θ_T , consider the classical mean field energy

$$E = -\mathbf{H} \cdot \frac{\mathbf{M}}{M_0} + K_4(M_x^4 M_y^4 + M_z^4)/M_0^4 + K_6[M_x^6 + M_y^6 + M_z^6 - \frac{15}{4}(M_x^4 M_y^2 + M_y^4 M_x^2 + M_z^2 M_y^4 + M_y^2 M_z^4 + M_z^2 M_x^4 + M_x^2 M_z^4)]/M_0^6$$

where K_4 and K_6 are phenomenological anisotropy constants. We have calculated magnetisation curves by minimising E with respect to \mathbf{M} for various directions of \mathbf{H} . In figure 3 are shown calculated magnetisation curves with $K_4 = -1$ and $K_6 = 0.5$. The discontinuity for $\theta = 0$ is 15% which corresponds to the situation for DyAl_2 at $T \simeq 20$ K.

B. Barbara et al., J. Phys. C: Solid State Phys. 11 L183 (1978)

Magnetic anisotropy

- Intrinsic symmetries of the physical properties reduce the number of independent components of anisotropy tensors.
 - The energy of the system is the same for both opposite orientations of magnetic moment.
- From Eq. (1) we have:

$$\sum_{i=1,2,3} b_i \alpha_i = \sum_{i=1,2,3} b_i (-\alpha_i) \quad \text{for all } \alpha_i \Rightarrow b_1 = b_2 = b_3 = 0$$

- The magnetocrystalline anisotropy energy may not depend on odd powers of direction cosines α . Consequently all odd rank tensors in the expansion (1) are identically null [1].

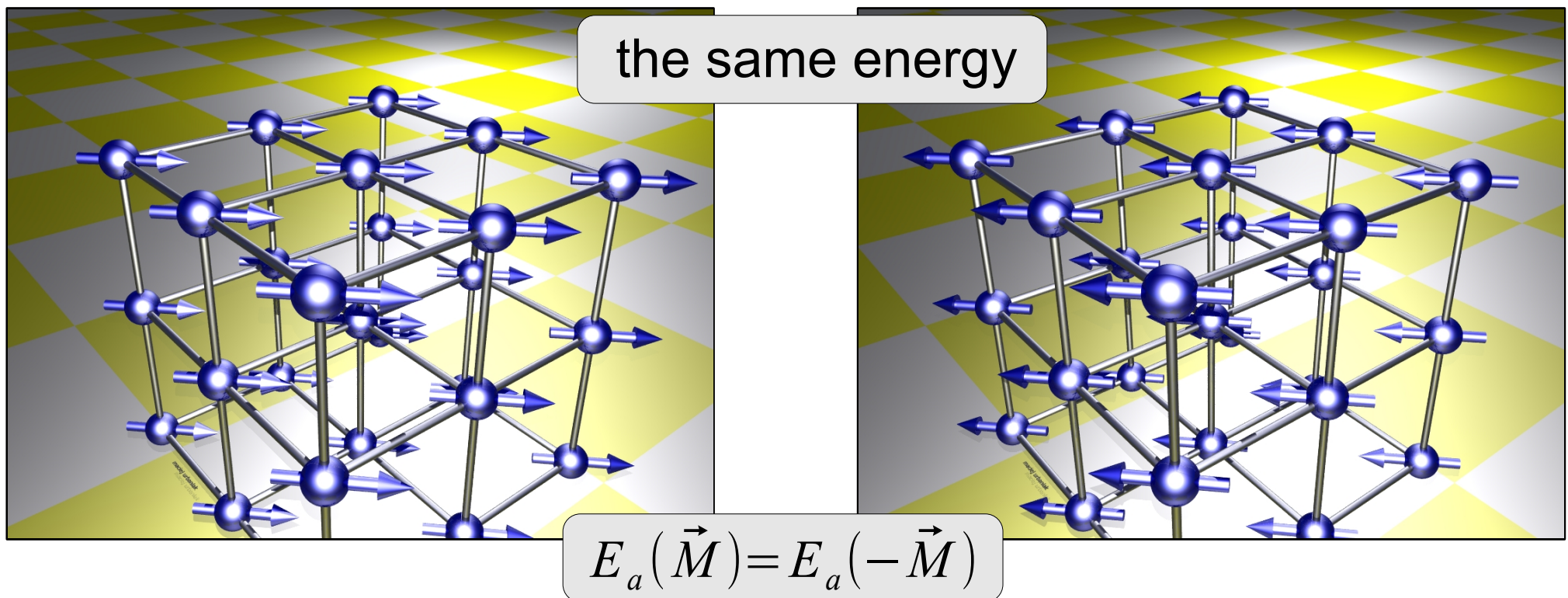

Magnetic anisotropy – symmetry of crystals

- Neumann's Principle:

The symmetry elements of any physical property of crystal must include all the symmetry elements of the point group* of the crystal.

- Consider a cubic crystal system with a 3-fold rotation axis [111] and the first nonvanishing anisotropy tensor (second rank):

$$b_{ij} = \begin{bmatrix} b_{11} & b_{12} & b_{13} \\ b_{21} & b_{22} & b_{23} \\ b_{31} & b_{32} & b_{33} \end{bmatrix}$$

- The transformation matrix corresponding to that rotation is:

$$M = \begin{pmatrix} 0 & 0 & 1 \\ 1 & 0 & 0 \\ 0 & 1 & 0 \end{pmatrix}$$

and coordinates transform according to the following rule: $a'_i = \sum_j M_{ij} a_j$

- Voigt's Principle:

The conditions of Neumann's principle are fulfilled if the physical property of the crystal is described by the tensor which is invariant under point symmetry operations which leave the crystal unchanged

•It follows that the physical property tensor must fulfill the condition $b = M^T b M$ for all symmetry operations of the point group.

*A point group is a group of symmetry operations all of which leave at least one point unmoved.

Magnetic anisotropy – symmetry of crystals

- From Voigt's principle it follows for tensor b :

$$b = M^T b M^*$$

$$b_{ij} = \begin{pmatrix} 0 & 1 & 0 \\ 0 & 0 & 1 \\ 1 & 0 & 0 \end{pmatrix} \begin{bmatrix} b_{11} & b_{12} & b_{13} \\ b_{21} & b_{22} & b_{23} \\ b_{31} & b_{32} & b_{33} \end{bmatrix} \begin{pmatrix} 0 & 0 & 1 \\ 1 & 0 & 0 \\ 0 & 1 & 0 \end{pmatrix} = \begin{bmatrix} b_{22} & b_{23} & b_{21} \\ b_{32} & b_{33} & b_{31} \\ b_{12} & b_{13} & b_{11} \end{bmatrix}$$

rotation by 120Deg about [111] direction

effect of the rotation of the crystal on tensor b_{ij}

- Comparing the elements of both (identical) tensors we get:

$b_{11} = b_{22}$	$b_{12} = b_{23}$	$b_{13} = b_{21}$	→
$b_{21} = b_{32}$	$b_{22} = b_{33}$	$b_{23} = b_{31}$	
$b_{31} = b_{12}$	$b_{32} = b_{13}$	$b_{33} = b_{11}$	

$$\begin{aligned}
 b_{11} &= b_{22} = b_{33} = \mathbf{a} \\
 b_{21} &= b_{32} = b_{13} = \mathbf{b} \\
 b_{31} &= b_{12} = b_{23} = \mathbf{c}
 \end{aligned}$$

- The invariance in respect the 120 Deg rotation leaves only **3 independent components**:

$$b_{ij} = \begin{bmatrix} a & c & b \\ b & a & c \\ c & b & a \end{bmatrix}$$

*transpose of a matrix: A matrix which is formed by turning all the rows of a given matrix into columns and vice-versa. The transpose of matrix A is written A^T (www.mathwords.com)

Magnetic anisotropy – symmetry of crystals

$$b = M^T b M$$

- We apply the same procedure again, but this time with other symmetry element of cubic crystal, namely 90Deg rotation around z-axis:

$$b_{ij} = \begin{pmatrix} 0 & 1 & 0 \\ -1 & 0 & 0 \\ 0 & 0 & 1 \end{pmatrix} \begin{bmatrix} a & c & b \\ b & a & c \\ c & b & a \end{bmatrix} \begin{pmatrix} 0 & -1 & 0 \\ 1 & 0 & 0 \\ 0 & 0 & 1 \end{pmatrix} = \begin{bmatrix} a & -b & c \\ -c & a & -b \\ b & -c & a \end{bmatrix}$$

rotation by 90Deg about [001] direction

effect of the rotation of the crystal on tensor b_{ij}

- Comparing the elements of the first row of both (identical) tensors we get:

$$c = -b, \quad b = c \Rightarrow b = c = 0$$

- It follows that the second rank tensor consistent with the above two symmetry operations possesses **one independent component**:

$$b_{ij} = \begin{bmatrix} a & 0 & 0 \\ 0 & a & 0 \\ 0 & 0 & a \end{bmatrix}$$

- Similar analysis can be performed for other tensors in the expansion (1):

$$E_{crystal}(\vec{M}) = b_0 + \sum_{i=1,2,3} b_i \alpha_i + \sum_{i,j=1,2,3} b_{ij} \alpha_i \alpha_j + \sum_{i,j,k=1,2,3} b_{ijk} \alpha_i \alpha_j \alpha_k + \dots \quad (1)$$

Magnetic anisotropy – symmetry of crystals

- Inserting tensor b into the third term of expansion (1) we get:

$$\sum_{i,j=1,2,3} b_{ij} \alpha_i \alpha_j = a (\alpha_1^2 + \alpha_2^2 + \alpha_3^2) = a \quad \text{- independent of the orientation of magnetic moment}$$

- In cubic system there are no second order terms in the expansion of energy in directional cosines [1].
- Using similar procedure we obtain the complete expression for the energy contribution related to the orientation of magnetic moment in cubic system [1]:

$$E_{crystal}(\vec{M}, T) = K_0(T) + K_1(T)(\alpha_1^2 \alpha_2^2 + \alpha_2^2 \alpha_3^2 + \alpha_3^2 \alpha_1^2) + K_2(T) \alpha_1^2 \alpha_2^2 \alpha_3^2$$

-the coefficients $K_0, K_1 \dots$ are the linear combinations of tensor components $b_{11}, b_{1111}, b_{111111}$ etc. [4].

- For other crystal systems the similar procedure is employed to obtain the $E_{crystal}(\vec{M}, T)$ expressions.
- For hexagonal crystals the energy can be expressed as [1]:

$$E_{crystal}(\vec{M}, T) = K_0(T) + K_1(T)(\alpha_1^2 + \alpha_2^2) + K_2(T)(\alpha_1^2 + \alpha_2^2)^2 + \dots$$

which is usually expressed, using trigonometric identities, as:

$$E_{crystal}(\vec{M}, T) = K_0(T) + K_1(T) \sin^2 \theta + K_2(T) \sin^4 \theta + \dots \quad (2)$$

Magnetic anisotropy – symmetry of crystals

- Inserting tensor b into the third term of expansion (1) we get:

$$\sum_{i,j=1,2,3} b_{ij} \alpha_i \alpha_j = a (\alpha_1^2 + \alpha_2^2 + \alpha_3^2) = a \quad \text{- independent of the orientation of magnetic moment}$$

- In cubic system there are no second order terms in the expansion of energy in directional cosines [1].
- Using similar procedure we obtain the complete expression for the energy contribution related to the orientation of magnetic moment in cubic system [1]:

$$E_{crystal}(\vec{M}, T) = K_0(T) + K_1(T)(\alpha_1^2 \alpha_2^2 + \alpha_2^2 \alpha_3^2 + \alpha_3^2 \alpha_1^2) + K_2(T) \alpha_1^2 \alpha_2^2 \alpha_3^2$$

- the coefficients $K_0, K_1 \dots$ are the linear combinations of tensor components $b_{11}, b_{1111}, b_{111111}$ etc. [4].

- The terms of the type α_i^4 are omitted since because of the identity [4,5]:

$$2(\alpha_1^2 \alpha_2^2 + \alpha_2^2 \alpha_3^2 + \alpha_3^2 \alpha_1^2) + \alpha_1^4 + \alpha_2^4 + \alpha_3^4 = 1$$

they can be incorporated into K_0, K_1 terms.

- The terms of the type α_i^6 can be similarly replaced by $\alpha_i^2 \alpha_j^2$ and $\alpha_1^2 \alpha_2^2 \alpha_3^2$ terms [6].

Magnetic anisotropy

- Number of independent components of the (second rank) tensor depends on the crystal symmetry

- In crystals of cubic system there is one independent component of the tensor.

- Hexagonal systems are characterized by two independent components of the second rank tensors.

ТАБЛИЦА 3

Влияние кристаллографической симметрии на свойства, описываемые симметричными тензорами второго ранга

Оптическая классификация	Системы	Характеризующая симметрия *	Вид характеристической поверхности и ее ориентация	Число независимых коэффициентов	Тензор, приведенный к осям принятой ориентации **
Изотропная среда	Кубическая	Четыре оси третьего порядка	Сфера	1	$\begin{bmatrix} S & 0 & 0 \\ 0 & S & 0 \\ 0 & 0 & S \end{bmatrix}$
Одноосные кристаллы	Тетрагональная	Одна ось четвертого порядка	Поверхность вращения вокруг главной оси симметрии $x_3 (z)$	2	$\begin{bmatrix} S_1 & 0 & 0 \\ 0 & S_1 & 0 \\ 0 & 0 & S_3 \end{bmatrix}$
	Гексагональная	Одна ось шестого порядка			
	Тригональная	Одна ось третьего порядка			
Двухосные кристаллы	Орторомбическая	Три взаимно перпендикулярные оси второго порядка; осей высшего порядка нет	Произвольная поверхность второго порядка с осями x_1, x_2, x_3 , параллельными осям второго порядка x, y, z	3	$\begin{bmatrix} S_1 & 0 & 0 \\ 0 & S_2 & 0 \\ 0 & 0 & S_3 \end{bmatrix}$
	Моноклинная	Одна ось второго порядка	Произвольная поверхность второго порядка с одной осью x_2 , параллельной оси второго порядка y	4	$\begin{bmatrix} S_{11} & 0 & S_{31} \\ 0 & S_{22} & 0 \\ S_{31} & 0 & S_{33} \end{bmatrix}$
	Триклинная	Центр симметрии или отсутствие симметрии	Произвольная поверхность второго порядка. Положение относительно кристаллографических осей не фиксировано	6	$\begin{bmatrix} S_{11} & S_{12} & S_{31} \\ S_{12} & S_{22} & S_{23} \\ S_{31} & S_{23} & S_{33} \end{bmatrix}$

* Оси симметрии могут быть поворотными или инверсионными; см. также стр. 335.
 ** Ориентация осей x_1, x_2, x_3 поверхности второго порядка по отношению к кристаллографическим осям x, y, z и элементам симметрии указана в табл. 4. Добавочные замечания о выборе систем координат см. в приложении 3.

image source: Дж. Най Физические Свойства Кристаллов
 Издательство МИР 1967

Magnetic anisotropy – torsion curves

- Torque curve – depicts the torque required to rotate the magnetization away from an easy direction as a function of the angle of rotation [3].
- Let us consider a uniaxial anisotropy crystal with easy axis lying in the plane parallel to the external magnetic field.
- Let the magnetocrystalline energy of the crystal be described by the expression [see eq. (2)]:

$$E_{crystal}(\vec{M}, T) = K_1(T) \sin^2 \theta$$

- If the sample is saturated and the easy axis is turned by the angle θ from the initial position (i.e., easy-axis parallel to the field) the magnetic moment of the sample (parallel to \mathbf{H}) exerts a torque on the crystal. For unit volume of the crystal the torque is:

$$L = -\frac{dE}{d\theta} = 2 K_1 \cos \theta \sin \theta$$

- Fitting the measured dependence one can find anisotropy coefficients

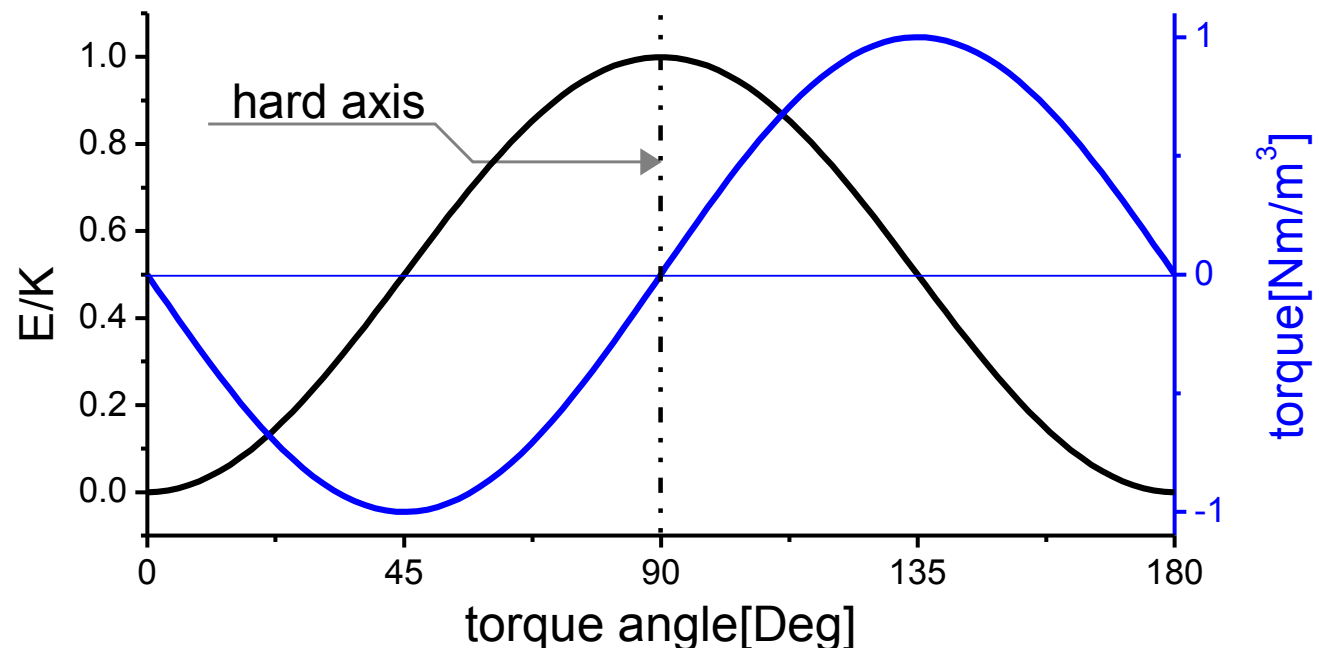

Magnetic anisotropy – torsion curves

- Torsion magnetometer:

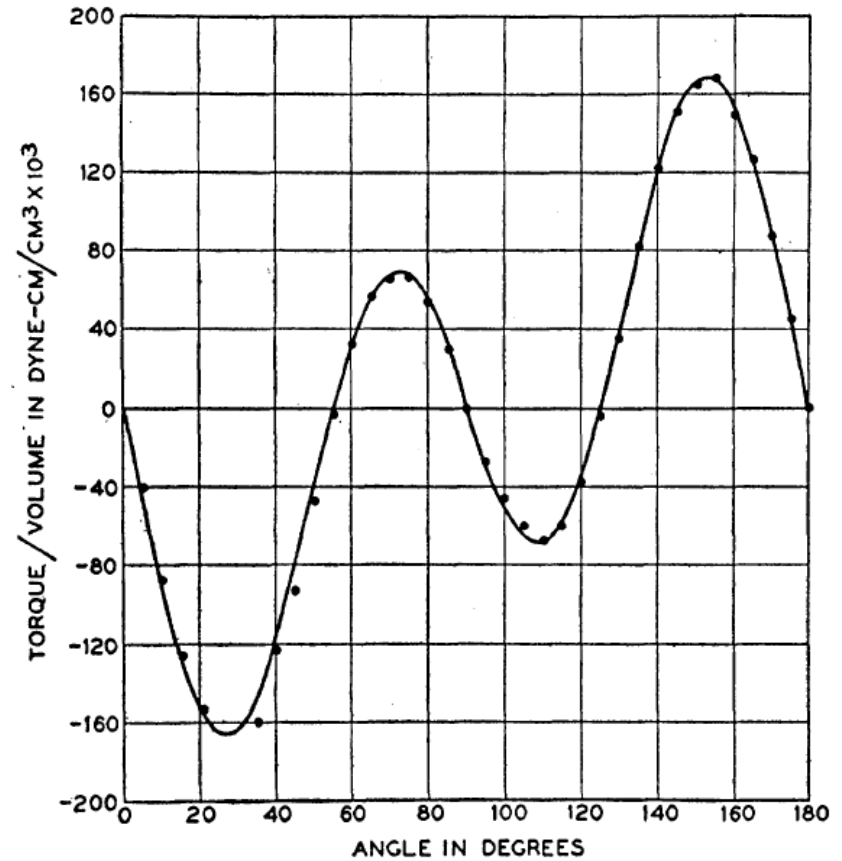
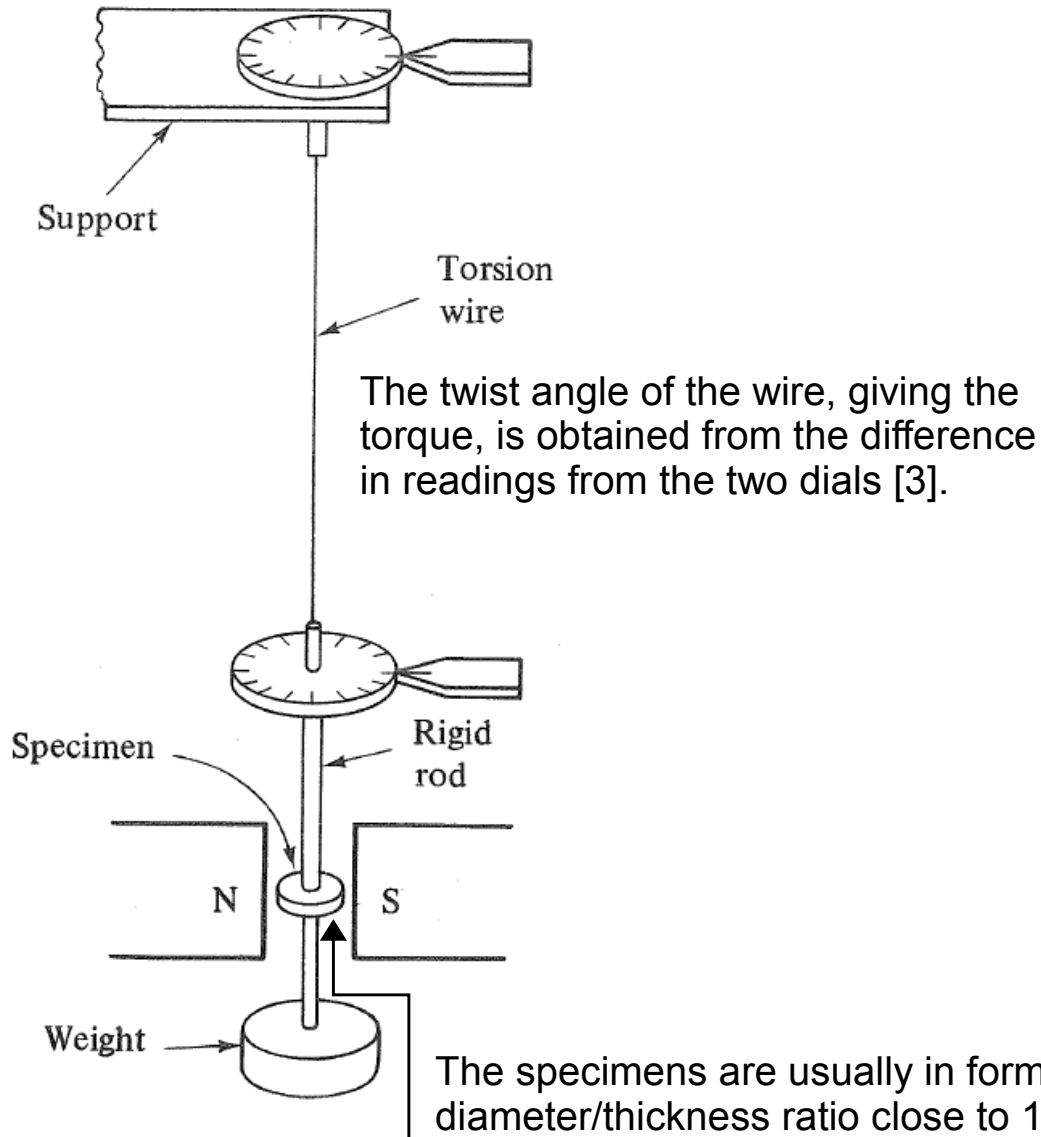

FIG. 5. Torque curve for a single crystal disk of silicon iron in the (110) plane, taken with an applied field of 5800 oersteds. The line is drawn according to Eq. (7) with $K_1 = 287,000$ and $K_2 = 100,000$.

H.J. Williams, Phys. Rev. 52, 747 (1937)

image source: B. D. Cullity, Introduction to magnetic materials, Addison-Wesley, Reading, Massachusetts 1972

Magnetic anisotropy – torsion curves

- Torsion cantilever:

torsion beam

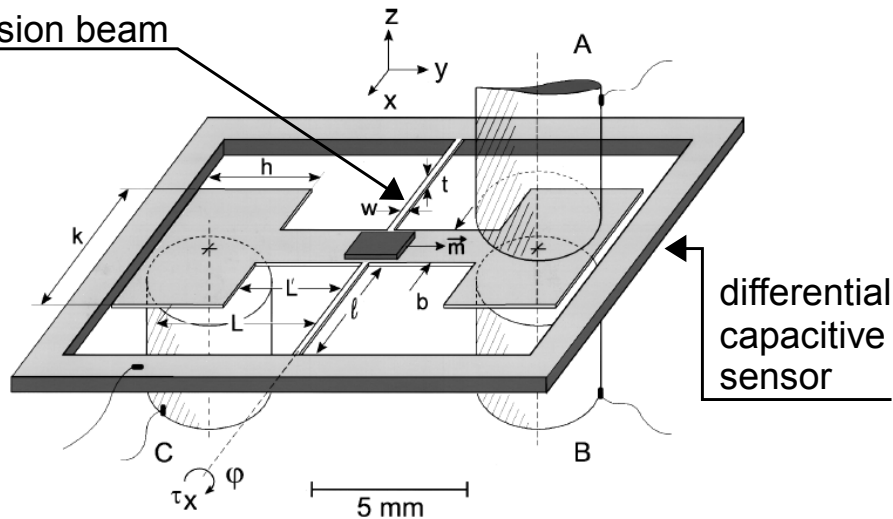

FIG. 1. Schematic view of the capacitive torque cantilever with torsion arms, capacitor plates, and counterelectrodes A, B, and C. A sample with magnetic moment \mathbf{m} is fixed in its center. The differential detection is made either with electrodes A and B or with electrodes B and C.

- Silicon torsion bar plays a role of the torsion wire
- The deflection (rotation) of the torsion bar is detected
- Sensitivity exceeds 5×10^{-13} Nm

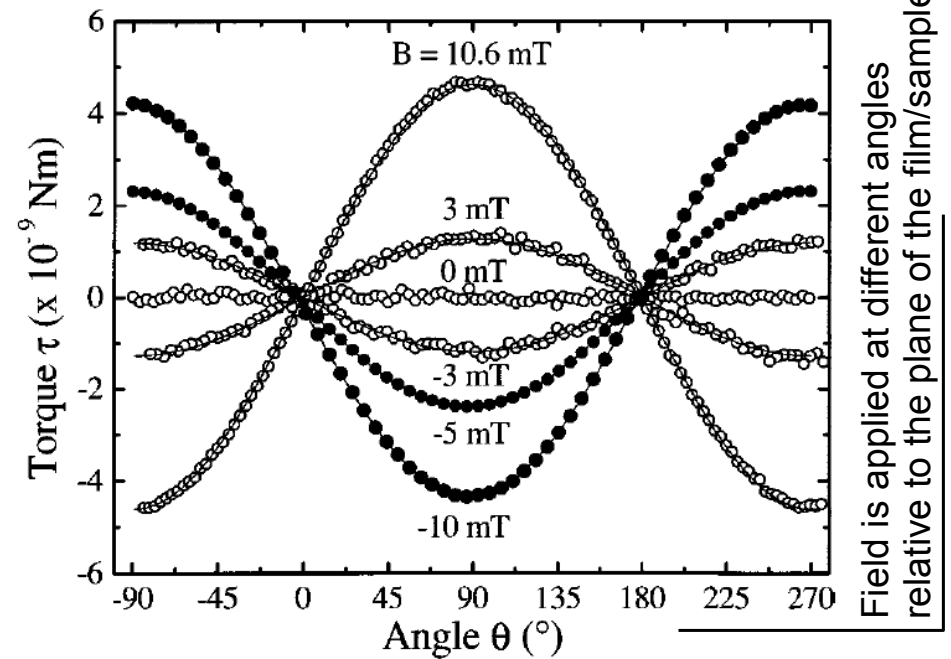

FIG. 3. Angular dependence of the torque signal produced by the magnetic moment of a $1 \times 1 \text{ mm}^2$ Fe_2O_3 magnetic audiotape measured at $T = 293 \text{ K}$ for different applied magnetic fields. The data taken with a commercial capacitance bridge (circles) show more scattering than those taken with our custom-made bridge (bullets). In the latter case, the data points were taken at increasing and decreasing angles and overlap exactly. Solid lines are fits to the data with a simple sine function.

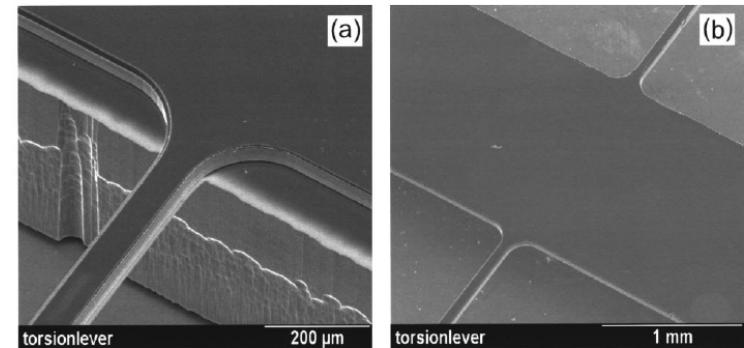

FIG. 2. Scanning electron micrographs with details of the torsion bars (a) at the junction with the thicker frame, and (b) across the center of the cantilever platform.

C. Rossel et al., Rev. Sci. Instrum. **69**, 3199 (1998)

Magnetic anisotropy – energy surfaces

- *Energy surface* – the distance from origin along the given direction is proportional to magnetocrystalline energy of the crystal with magnetization along that direction.
- We start from the expression of the magnetocrystalline energy for cubic crystals:

$$E_{crystal}(\vec{M}, T) = K_0(T) + K_1(T)(\alpha_1^2 \alpha_2^2 + \alpha_2^2 \alpha_3^2 + \alpha_3^2 \alpha_1^2) + K_2(T) \alpha_1^2 \alpha_2^2 \alpha_3^2 + \dots$$

- For $K_0=1$, $K_1=0$ and $K_2=0$ we have isotropic energy surface:

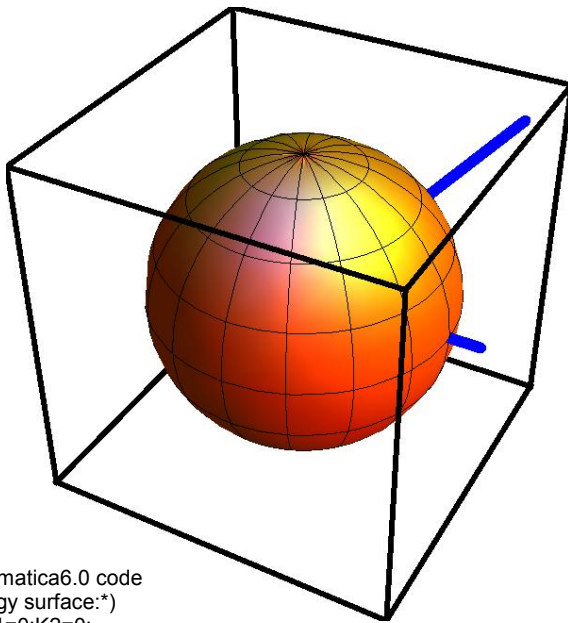

- Energy does not depend on the orientation of the magnetic moment

- The magnetization reversal (hysteresis) itself does not depend on K_0 but to show the difference between the cases of $K_1 > 0$ and $K_1 < 0$ we need a reference level – the surface of the sphere.

```
(*Mathematica6.0 code
for energy surface:*)
K0=1;K1=0;K2=0;
a1=Sin[teta] Cos[fi];
a2=Sin[teta] Sin[fi];
a3=Cos[teta];
Energy=K0+K1(a1^2 a2^2+a3^2 a2^2+a1^2 a3^2)+K2(a1^2 a2^2 a3^2);
xsurface=Energy a1;
ysurface=Energy a2;
zsurface=Energy a3;
obrazek=ParametricPlot3D[{xsurface,ysurface,zsurface},{fi,0,2[Pi]},{teta,-[Pi],[Pi]},{PlotStyle->{Orange,Specularity[White,10]},
ImageSize->600,PlotRange->{-1.2,1.2},Axes->None,AxesLabel->{X,Y,Z},BoxStyle->Directive[Thickness[0.01],Black]};
osdiag=Line[{{0,0,0},{1,1,1}}];
osx=Line[{{0,0,0},{1.2,0,0}}];
moment=Sphere[{1,1,1},1];
obrazekwy=Show[obrazek,Graphics3D[{Blue,Thickness[0.02],osx}],Graphics3D[{Blue,Thickness[0.02],osdiag}]
```

Magnetic anisotropy – energy surfaces

- Cubic crystals magnetocrystalline energy surfaces* for different anisotropy coefficients:

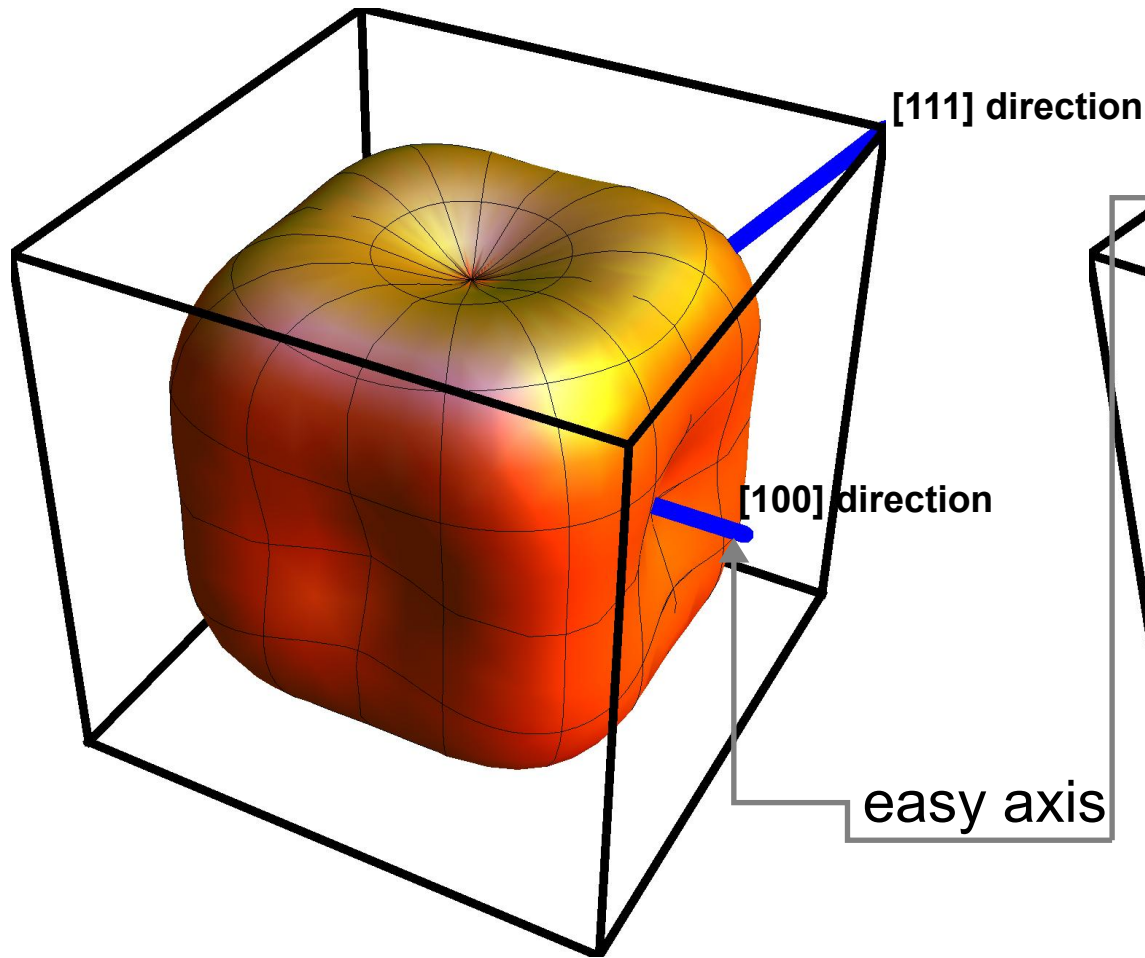

energy surface for $K_0=1$, $K_1=2$ and $K_2=0$

typicall for bcc cubic crystals (Fe)

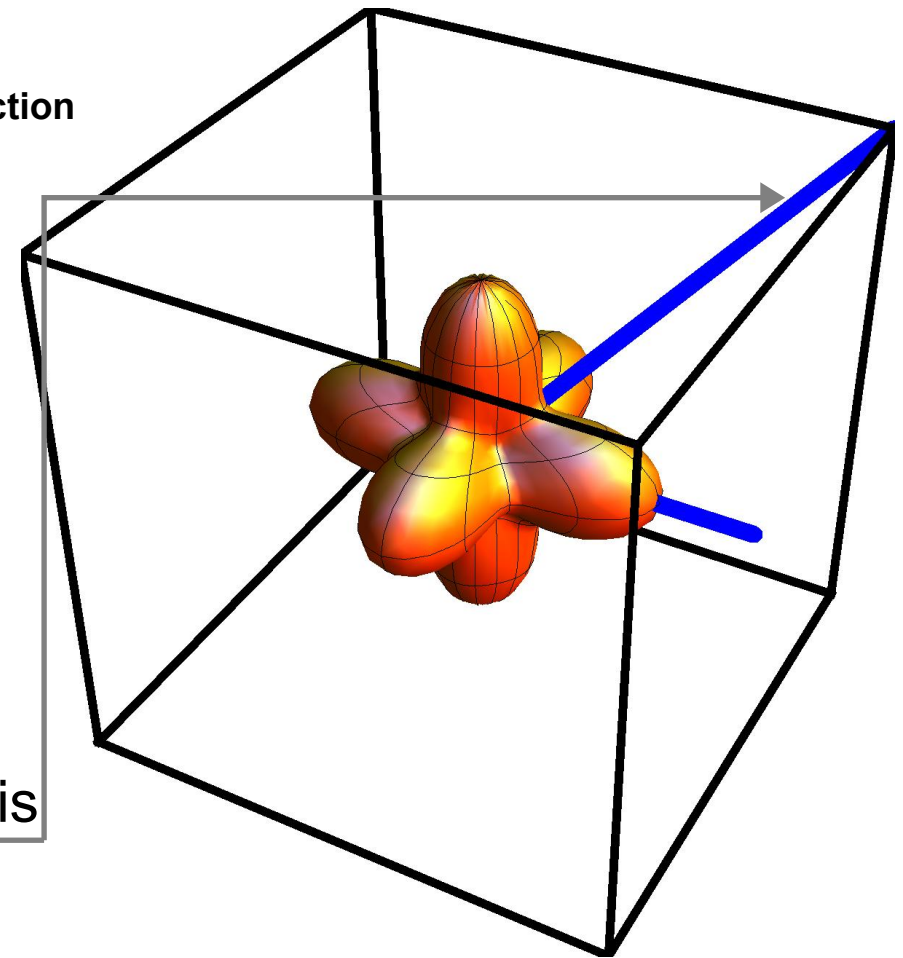

energy surface for $K_0=1$, $K_1=-2$ and $K_2=0$

typicall for fcc cubic crystals (Ni)

*both images have the same scale

Magnetic anisotropy – energy surfaces

- Cubic crystals magnetocrystalline energy surfaces* for different anisotropy coefficients:

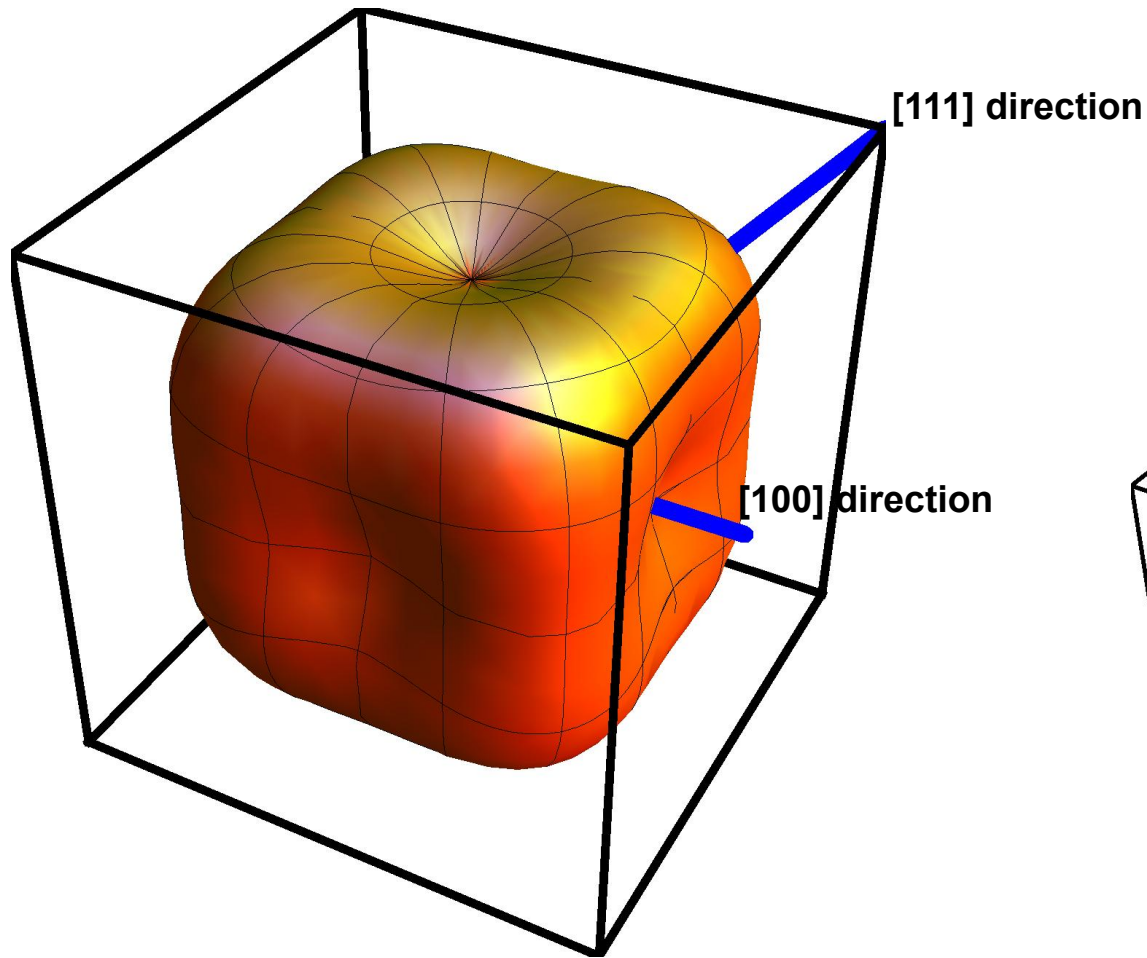

energy surface for $K_0=1$, $K_1=2$ and $K_2=0$

typical for bcc cubic crystals (Fe)

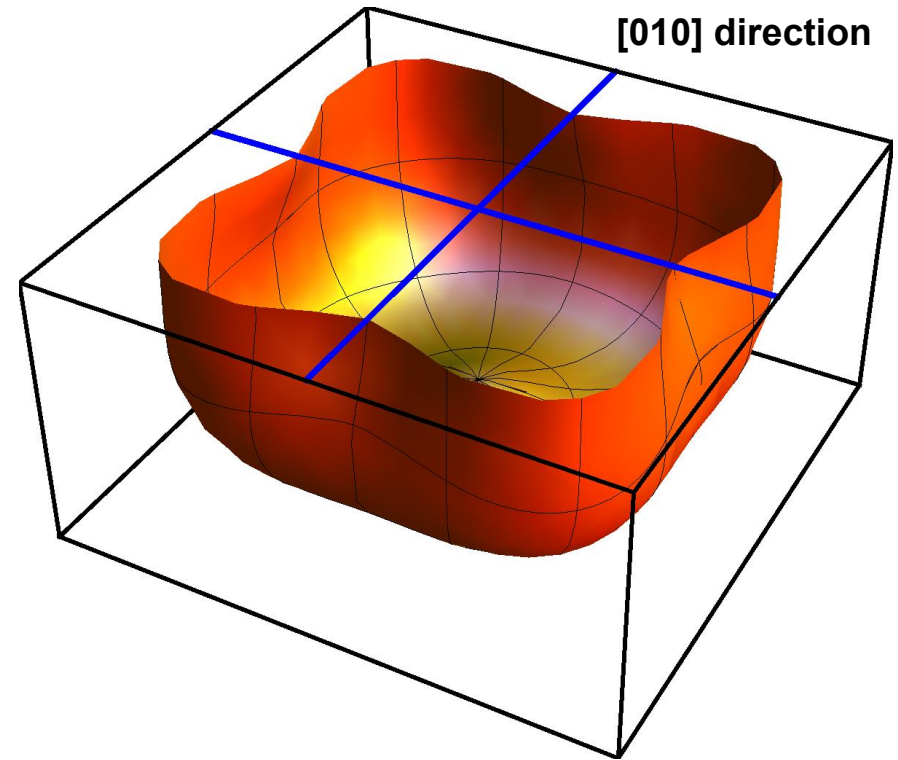

$\langle 1,0,0 \rangle$ – easy directions

*both images have the same scale

Magnetic anisotropy – energy surfaces

- Hexagonal crystals magnetocrystalline energy surfaces:

$$E_{\text{crystal}}(\vec{M}) = K_0 + K_1 \sin^2 \theta + K_2 \sin^4 \theta$$

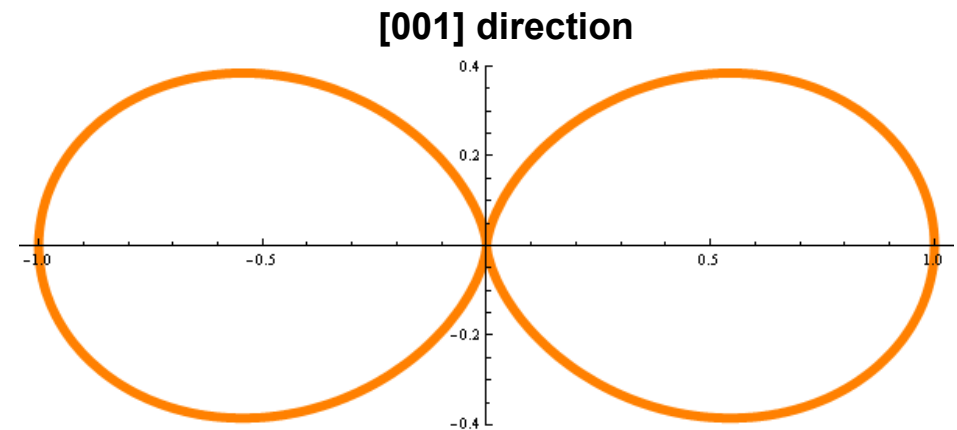
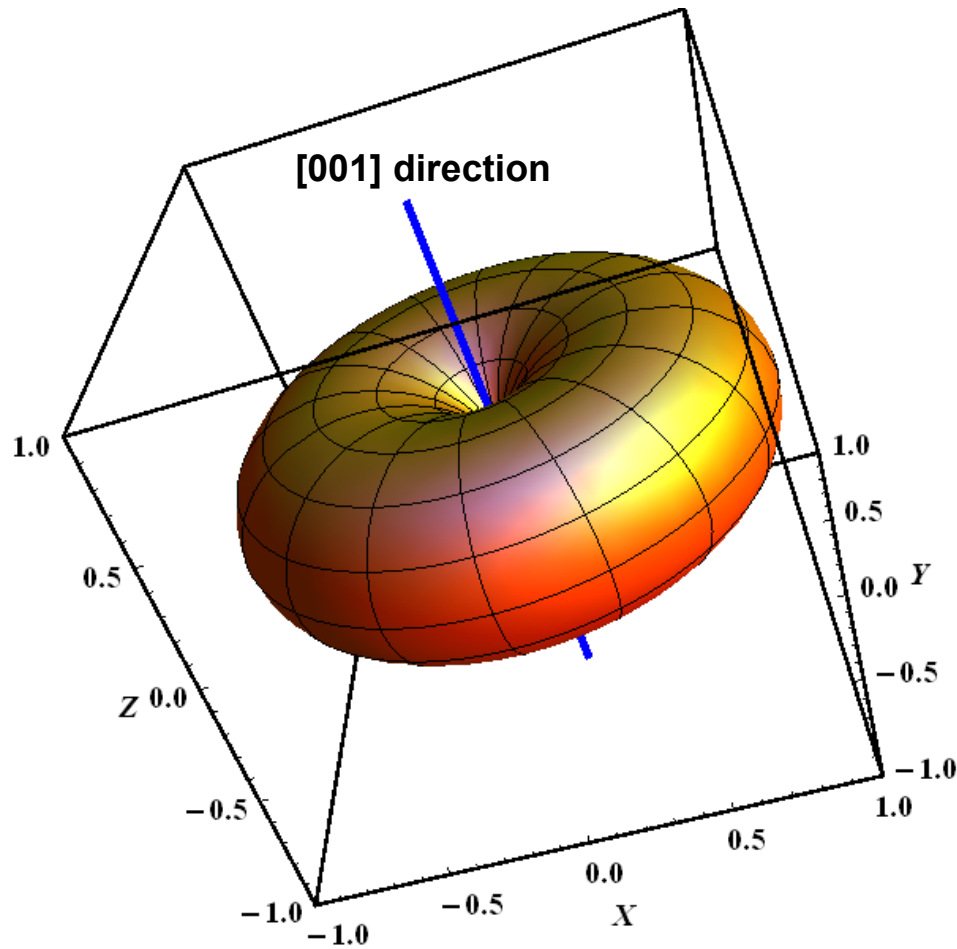

energy surface for $K_0=0$, $K_1=-1$ and $K_2=0$

typical for hcp cobalt crystals

[0,0,1] – easy direction

Energy surfaces – the influence of the external field

- Cubic crystals magnetocrystalline energy surfaces for different values of the external field applied along [111] direction*:

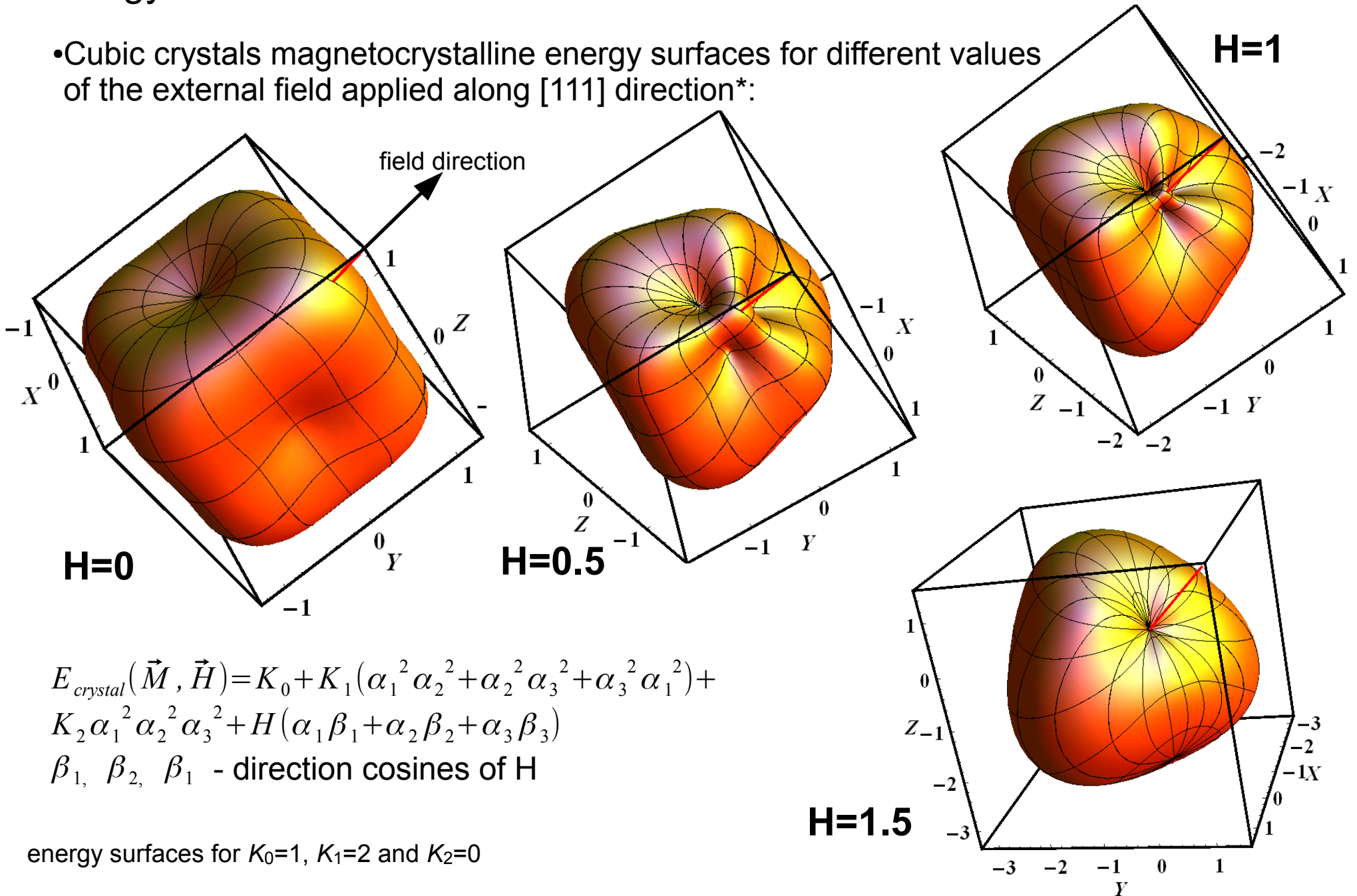

$$E_{crystal}(\vec{M}, \vec{H}) = K_0 + K_1(\alpha_1^2 \alpha_2^2 + \alpha_2^2 \alpha_3^2 + \alpha_3^2 \alpha_1^2) + K_2 \alpha_1^2 \alpha_2^2 \alpha_3^2 + H(\alpha_1 \beta_1 + \alpha_2 \beta_2 + \alpha_3 \beta_3)$$

$\beta_1, \beta_2, \beta_3$ - direction cosines of H

energy surfaces for $K_0=1, K_1=2$ and $K_2=0$

*images do not have the same scale

Energy surfaces – the influence of the external field

- Cubic crystals magnetocrystalline energy surfaces for different values of the external field applied along [111] direction*:

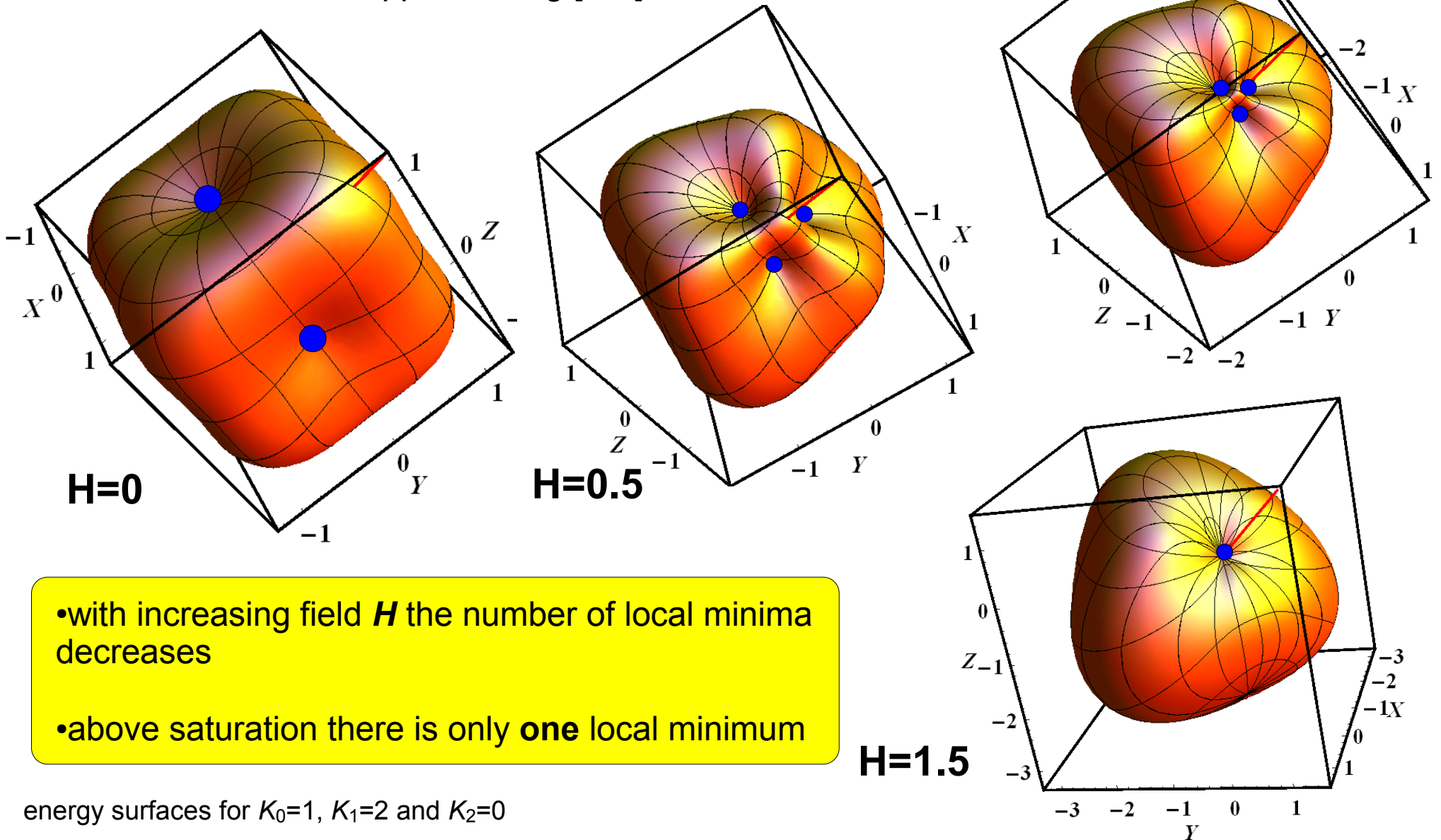

- with increasing field H the number of local minima decreases
- above saturation there is only **one** local minimum

energy surfaces for $K_0=1$, $K_1=2$ and $K_2=0$

*images do not have the same scale

Anisotropy constants of ferromagnetic elements

- Bulk magnetocrystalline anisotropy constants of basic ferromagnetic elements at 4.2K [1]:

	Fe (bcc)	Co (hcp)	Ni (fcc)
K_1 [J/m ³]	54800	760000	-126300
[meV/atom]	4.02×10^{-3}	5.33×10^{-2}	-8.63×10^{-3}
K_2 [J/m ³]	1960	100500	57800
[meV/atom]	1.44×10^{-5}	7.31×10^{-3}	3.95×10^{-3}

- Magnetocrystalline anisotropy of permalloy (Ni₈₁Fe₁₉):

$$K \approx 0 \text{ J/m}^3$$

- Magnetocrystalline anisotropy of rare-earth magnets [3]:

$$\text{YCo}_5 \quad K \approx 5.5 \times 10^6 \text{ J/m}^3$$

$$\text{SmCo}_5 \quad K \approx 7.7 \times 10^6 \text{ J/m}^3$$

Mixed anisotropies

- Consider the crystal in which two uniaxial anisotropies are present together [3]. We limit our discussion to second order terms [see Eq.(2)]:

$$E_A = K_0 + K_A \sin^2 \theta, \quad E_B = K_0 + K_B \sin^2(90 - \theta) = K_0 + K_B \cos^2 \theta$$

- The total energy of the moment is:

$$E_{total} = K'_0 + K_A \sin^2 \theta + K_B \cos^2 \theta$$

- If $K_A = K_B$ the energy is independent of θ :

$$E_{total} = K'_0 + K_B (\sin^2 \theta + \cos^2 \theta) + (K_A - K_B) \sin^2 \theta = K'_0 + K_B$$

Two equal uniaxial anisotropies at right angle are not equivalent to biaxial anisotropy.

- If K_A and K_B are not equal the equilibrium angle is given by:

$$\frac{\partial E_{total}}{\partial \theta} = \frac{\partial}{\partial \theta} (K_A - K_B) \sin^2 \theta = \frac{\partial}{\partial \theta} (K_A - K_B) \left(\frac{1 - \cos(2\theta)}{2} \right) = (K_A - K_B) \sin(2\theta) = 0$$

- Solutions are $\theta = 0^0, 90^0, 180^0$

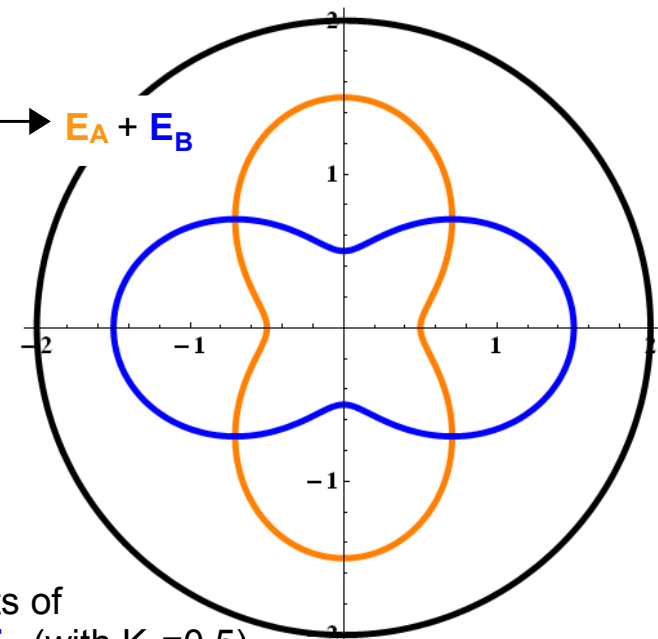
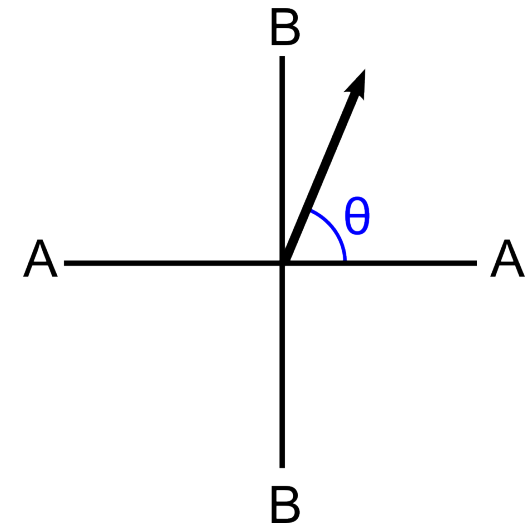

Polar plots of E_A and E_B (with $K_0=0.5$)

Mixed anisotropies

- From the second derivative (must be positive for minimum) we obtain [3]:

$$\frac{\partial^2 E_{total}}{\partial \theta^2} = 2(K_A - K_B) \cos(2\theta) \Rightarrow$$

$K_A > K_B$	$K_A < K_B$
Easy axis – $\theta = 0$ Deg	Easy axis – $\theta = 90$ Deg

The direction of easy magnetization is not along some axis lying between AA and BB axes but is along the axis pertaining to higher anisotropy.

- Case of the two uniaxial anisotropies which are not perpendicular:

- in case of anisotropies of equal strength the resultant easy axis CC lies midway between axes AA and BB

- otherwise the CC axes makes smaller angle with axis Pertaining to stronger anisotropy

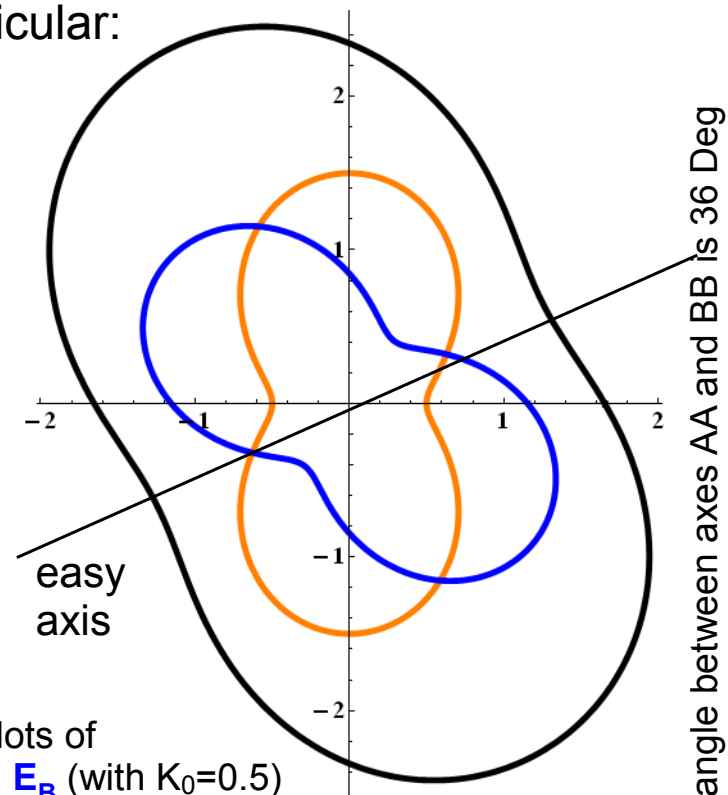
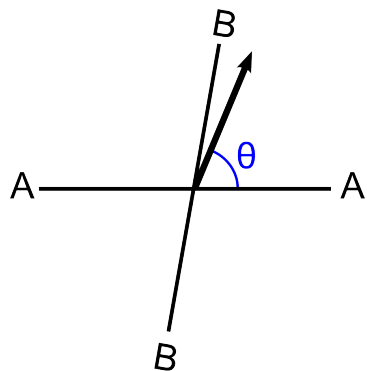

Spin-orbit coupling

- We consider an electron and the nucleus in a quasi-classical vector model [7].

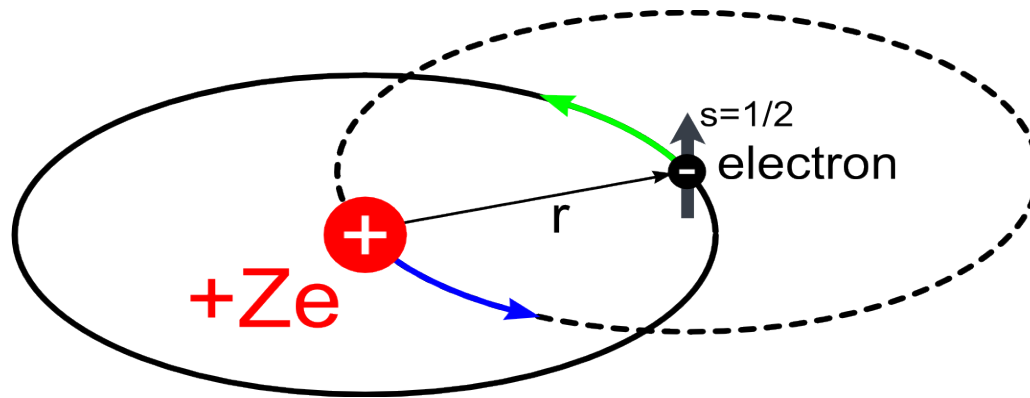

- The electron circulates around the nucleus of charge $+Ze$
- Alternatively the motion can be seen as a nucleus orbiting the electron (in its frame of reference)
- The circulating nucleus constitutes the electric current producing magnetic field H at the place of the electron

- From Biot-Savart law the field produced by the nucleus moving with velocity \mathbf{v} is:

$$\vec{B} = \int_{2\pi r} dB = \frac{\mu_0}{4\pi} \underbrace{|\mathbf{v}|(Ze)}_{\text{current}} \frac{d\hat{\mathbf{v}} \times (-\mathbf{r})}{r^3} \underbrace{2\pi r}_{\text{integration path}} = -\frac{\mu_0 Ze}{4\pi r^3} \vec{v} \times \vec{r}$$

$$dB = \frac{\mu_0 I}{4\pi} \frac{d\hat{\mathbf{l}} \times \vec{r}}{r^3}$$

- We know that $m_e \mathbf{r} \times \mathbf{v}$ is an angular momentum. We have then*:

$$\vec{B} = \frac{\mu_0 Ze}{8\pi r^3 m_e} \vec{L}$$

*relativistic calculation introduces a correction factor $\frac{1}{2}$ (Thomas factor [7])

Spin-orbit coupling

- The spin of the electrons acquires additional energy due to the field of nucleus:

$$\Delta E_{LS} = -\vec{\mu}_s \cdot \vec{B} = \frac{g_s \mu_B}{\hbar} \vec{S} \cdot \vec{B}$$

$$\Delta E_{LS} = g_s \mu_B \frac{\mu_0 Z e}{8 \pi r^3 m_e \hbar} \vec{S} \cdot \vec{L}$$

quasi-classical expression for spi-orbit coupling energy

- In hydrogen atoms the LS field is of the order on 1 T (for 0.1nm orbit) [7] and the energy of the interaction is of the order of several tenths of eV.
- In quantum mechanical calculations concerning transition ferromagnetic metals, in which magnetism is due to the d electrons, it is sufficient to consider only the coupling averaged over d-orbitals. The interaction energy is then [8]:

$$\Delta E_{LS} = \xi \vec{l} \cdot \vec{s}$$

Spin-orbit coupling

- The spin-orbit coupling depends on atomic number Z [8]:
 - within the given series of periodic table it increases like Z^2
 - for 3d metals ξ is of the order of 50-100meV

ferromagnetic elements

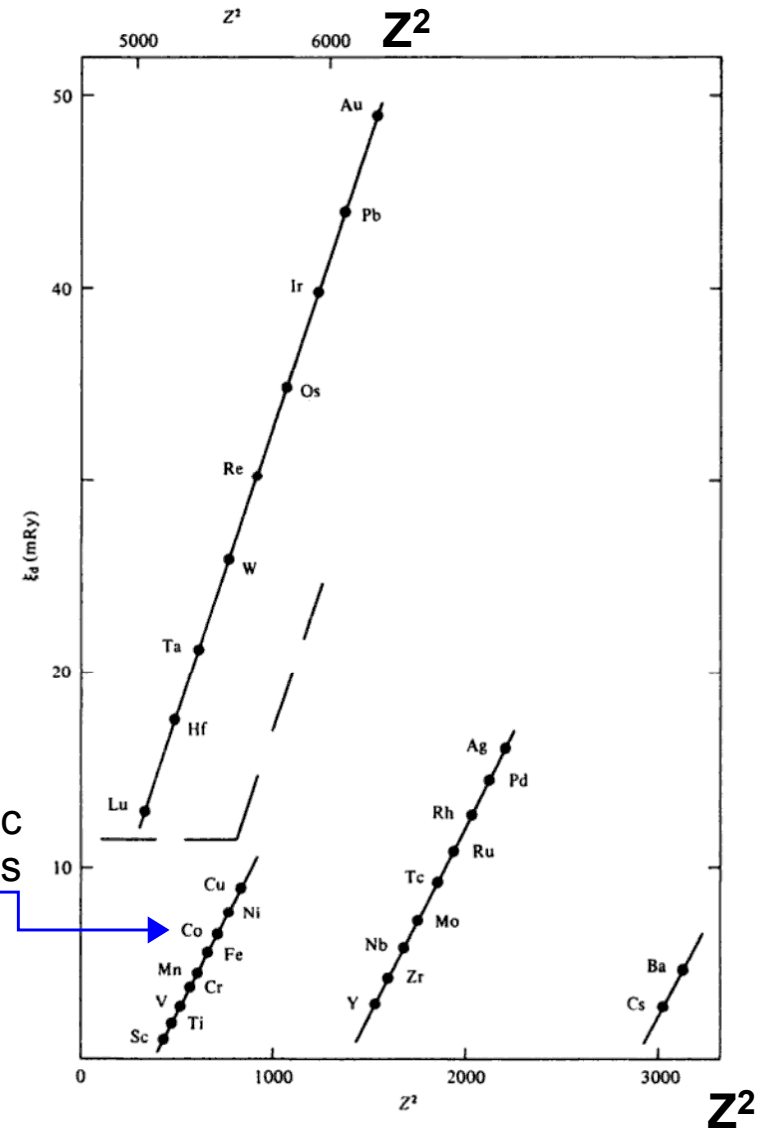

Fig. 5.14. Spin-orbit coupling parameter, $\xi_d(C_d)$, for the centre of the d-band, as a function of the square of the atomic number.

image source: A.R. Mackintosh, O. K. Andersen

The electronic structure of transition metals in *Electrons at the Fermi Surface* edited by M. Springford, Cambridge University Press 1980
retrieved from <http://books.google.pl>

Microscopic mechanism of magnetocrystalline anisotropy

- The spin of electron interacts with the crystal structure via spin orbit coupling

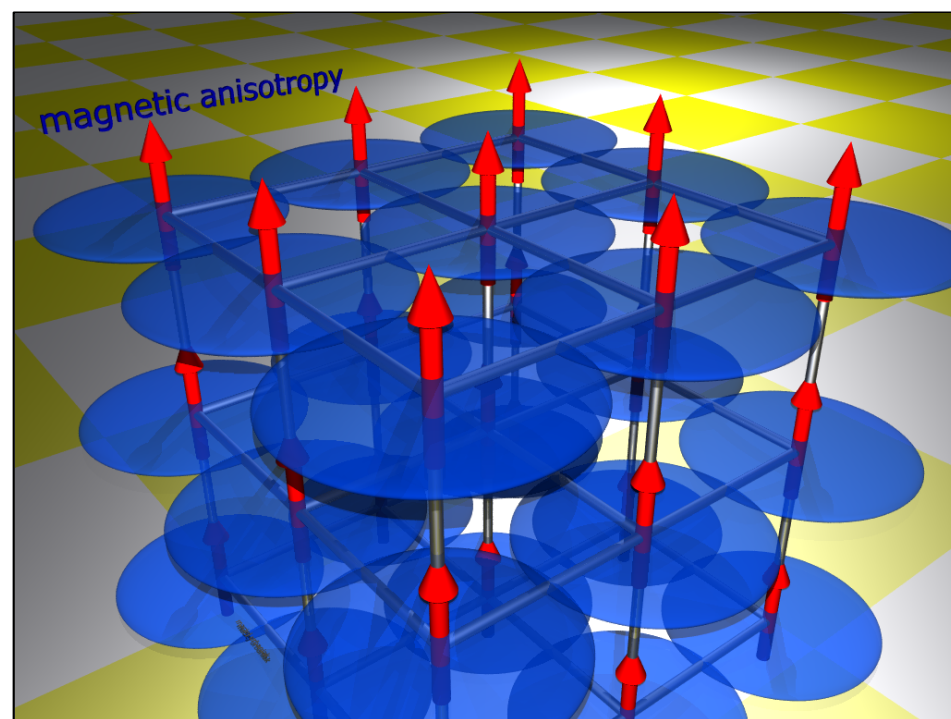
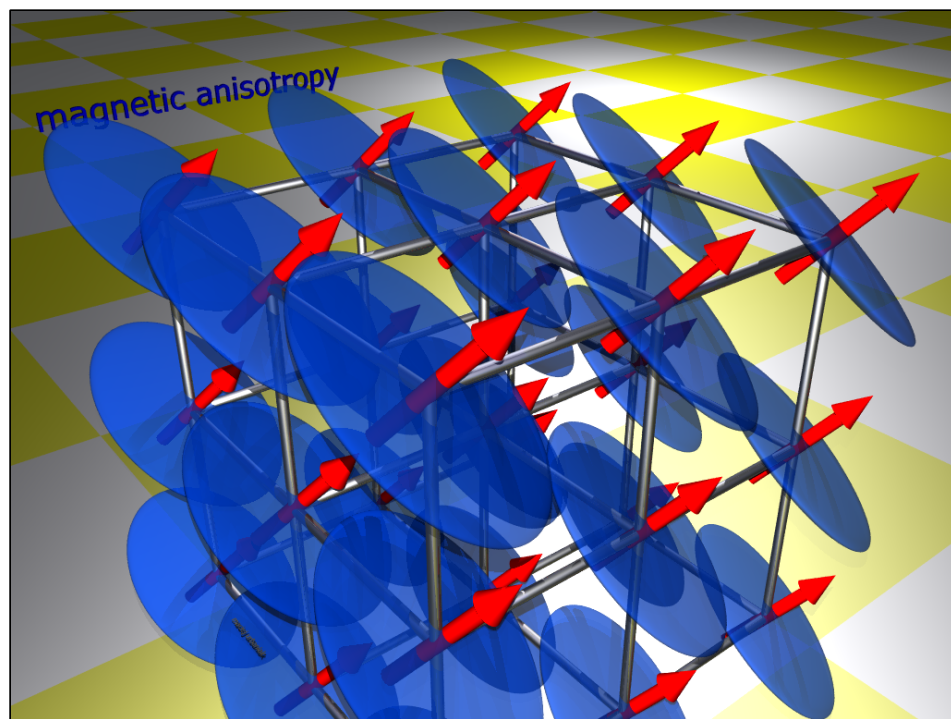

- Due to spin-orbit coupling different orientations of electron spins correspond to different orientations of **atomic orbitals** relative to crystal structure
- As a consequence some orientations of the resultant magnetic moment are energetically favorable – **easy directions**.

Stoner-Wohlfarth model*

- Describes magnetization reversal in single domain magnetic particles/films
- The reversal is characterized by the orientation of single magnetic moment
- The anisotropy may be of magnetocrystalline, shape etc. origin
- For the uniaxial anisotropy case the energy can be described as (compare magnetocrystalline anisotropy energy expression for hexagonal system) [8]:

$$E_{total} = K_0 + K_1 \sin^2 \theta - \vec{B} \cdot \vec{M} = K_0 + K_1 \sin^2 \theta - M B \cos(\gamma - \theta) \quad **$$

Zeeman energy

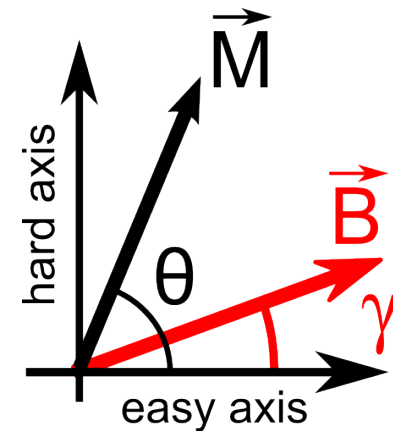

- The energy landscape for different values of B ($K_0=0, K_1=1, M=1, \gamma=30^\circ$):

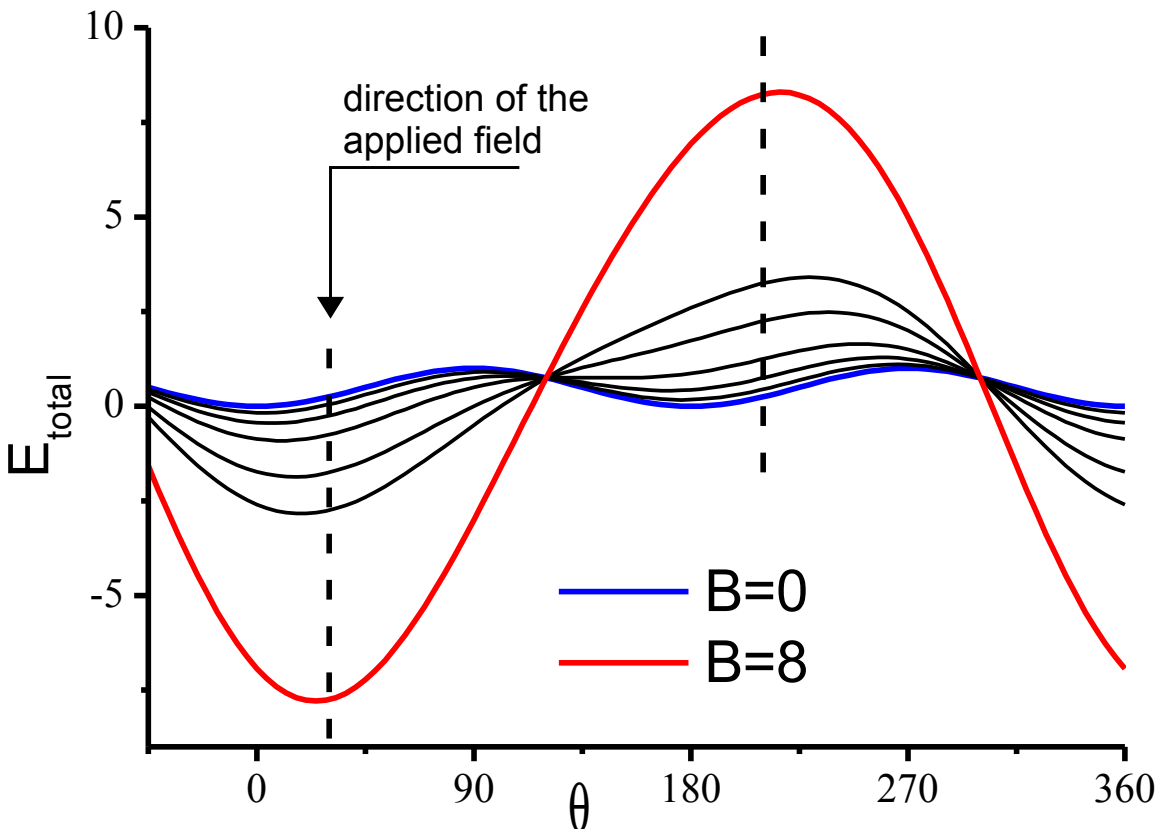

- On increasing the field the minima shift toward its direction
- The angle antiparallel to field corresponds to absolute maximum

*some times called macrospin model

** this expression is for a unit volume of the material:
 $M := MV$ [Am^2], $K = KV$ [J]

Stoner-Wohlfarth model

- The dependence $angle(field)$ obtained from the energy landscapes of the previous slide gives hysteresis loops:

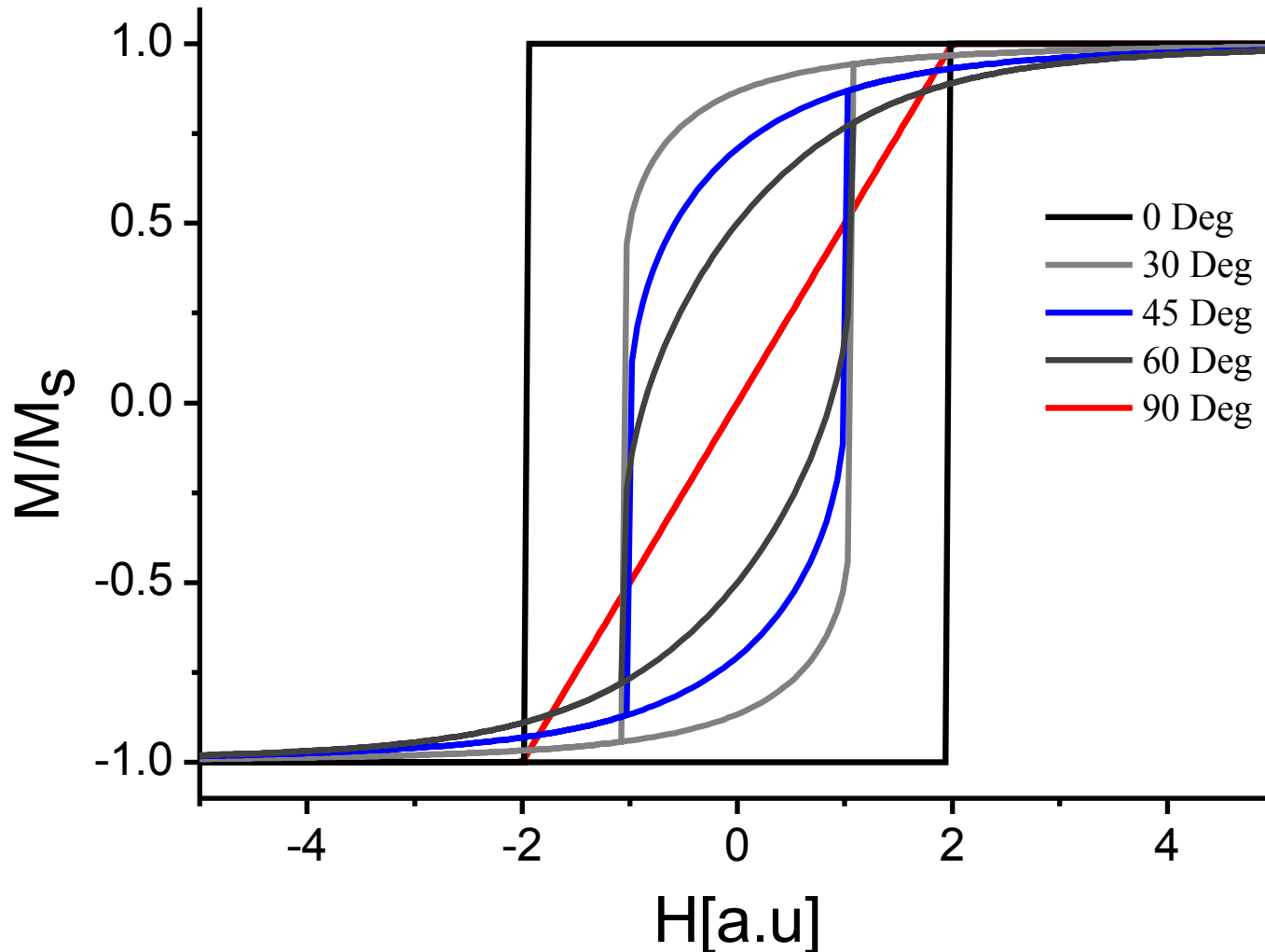

- For field applied along easy-axis the reversal is completely irreversible

- For field applied perpendicularly to EA direction the reversal is completely reversible

- For field applied in arbitrary direction magnetization is “partly reversible and partly irreversible” [9]

Stoner-Wohlfarth model

• *Hard axis reversal.* We can rewrite the expression for the total energy using components of the field parallel (B_x) and perpendicular (B_y) to easy axis [9]:

$$E_{total} = K_0 + K_1 \sin^2 \theta - M B \cos(\gamma - \theta) = K_0 + K_1 \sin^2 \theta - B_x M_x - B_y M_y = K_0 + K_1 \sin^2 \theta - B_x M \cos(\theta) - B_y M \sin(\theta)$$

• Energy becomes minimum at a specific angle which can be determined setting:

$$\frac{\partial E_{total}}{\partial \theta} = 2 K_1 \sin \theta \cos \theta + B_x M \sin(\theta) - B_y M \cos(\theta) = 0$$

• With $\alpha = \frac{2 K_1}{M}$ this can be written as:

$$\alpha \sin \theta \cos \theta + B_x \sin(\theta) - B_y \cos(\theta) = 0 \quad \text{or} \quad \frac{B_y}{\sin(\theta)} - \frac{B_x}{\cos(\theta)} = \alpha$$

• If field is applied perpendicularly to EA we have ($B_x=0$, $B_y=B$):

$$\sin(\theta) = \frac{B}{\alpha}$$

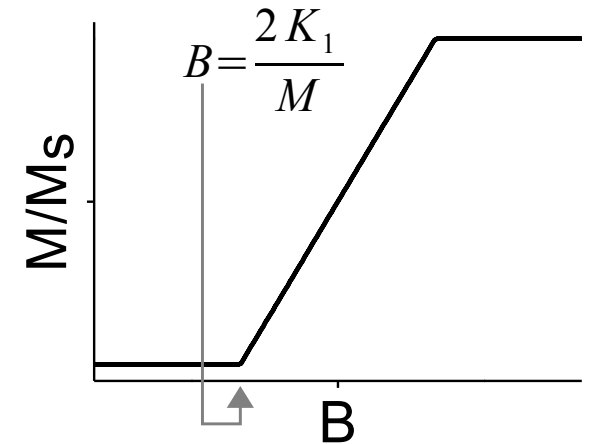

If field is applied perpendicularly to the easy axis the component of magnetization parallel to the field is a linear function of the external field up to saturation which happens at*:

$$B_s = \frac{2 K_1}{M}$$

*in practical applications $K[\text{Jm}^{-3}]$, $M[\text{Am}^{-1}]$

$B[\text{T}] = \frac{kG}{100}$
 $\left[\frac{K}{M} = \frac{\text{Jm}^3}{\text{Am}^2} = \frac{\text{J}}{\text{Am}^2} = \frac{\text{kg m m}^2 \text{ s}^{-2}}{\text{A}^2 \text{ m}^2} = \frac{\text{kg}}{\text{A}^2} \right]$

Stoner-Wohlfarth model – astroid curve

- Depending on the value of the external field there may one or two equilibrium orientations of magnetic moment. For a given field value the two orientations collapse to one when [9]:

$$\frac{\partial^2 E_{total}}{\partial \theta^2} = 0$$

- From the expression for the energy (previous slide) we have:

$$\frac{\partial^2 E_{total}}{\partial \theta^2} = \alpha (\cos^2 \theta - \sin^2 \theta) + B_x \cos(\theta) + B_y \sin(\theta) = 0$$

From previous slide:

$$\alpha = \frac{B_y}{\sin(\theta)} - \frac{B_x}{\cos(\theta)}$$

$$\frac{\partial^2 E_{total}}{\partial \theta^2} = \cos^2 \theta \sin^2 \theta \left(\frac{B_y}{\sin^3(\theta)} + \frac{B_x}{\cos^3(\theta)} \right) = 0$$

- We are looking for the solution of the set:

$$\alpha = \frac{B_y}{\sin(\theta)} - \frac{B_x}{\cos(\theta)}, \quad \frac{B_y}{\sin^3(\theta)} + \frac{B_x}{\cos^3(\theta)} = 0$$

$$\alpha + \frac{B_x}{\cos(\theta)} = \frac{B_y}{\sin(\theta)}, \quad \frac{B_y}{\sin(\theta)} \frac{1}{\sin^2(\theta)} + \frac{B_x}{\cos^3(\theta)} = 0$$

- By a direct substitution of the first equation into the second we get:

$$B_x = -\alpha \cos^3 \theta, \quad B_y = \alpha \sin^3 \theta$$

- Introducing reduced fields ($b_x = \frac{B_x}{\alpha} = -\cos^3 \theta$) it may be written as:

$$b_x^{2/3} + b_y^{2/3} = 1 \quad \text{equation of astroid}$$

Stoner-Wohlfarth model – astroid curve

- Stoner-Wohlfarth astroid separates region, in (H_x, H_y) plane, with two minima of energy from that with only one minimum*
- When the external field is changed so that the astroid is crossed the discontinuous changes of the orientation of magnetization can take place

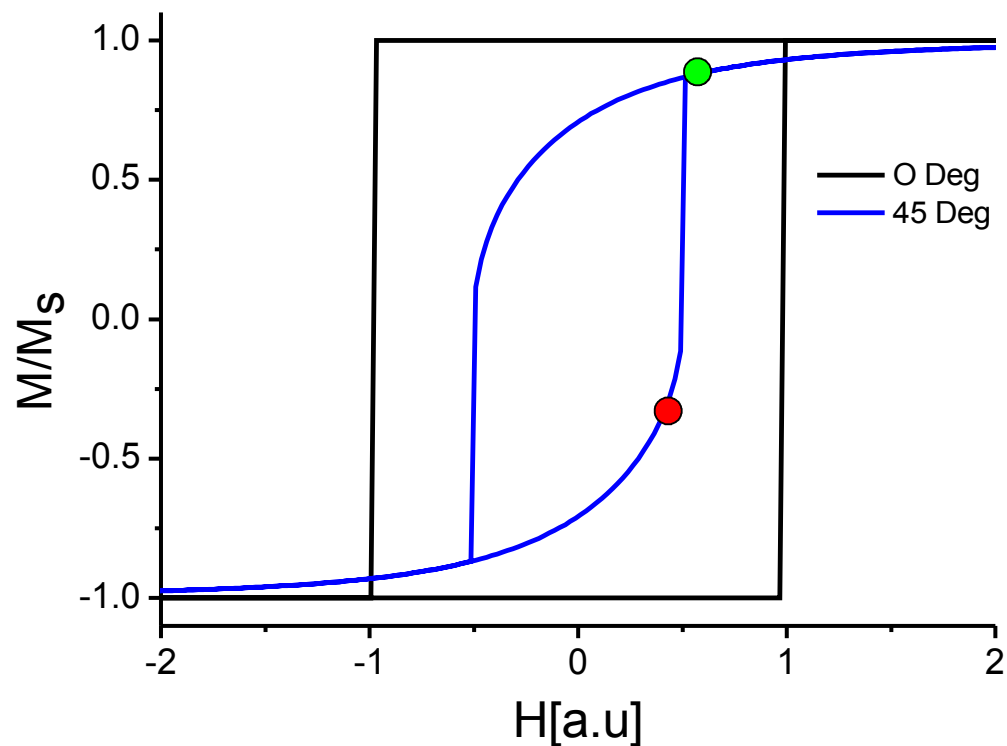
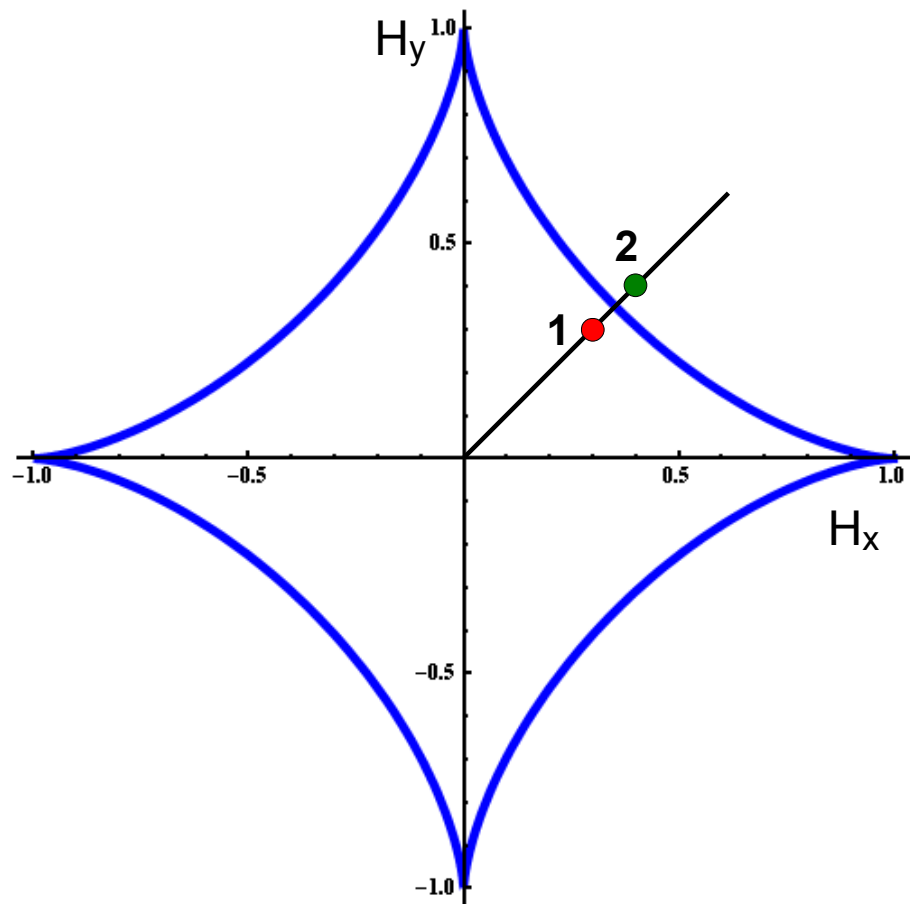

*Y. Henry PHYSICAL REVIEW B **79**, 214422 (2009)

Stoner-Wohlfarth model – astroid curve

- Stoner-Wohlfarth astroid separates region, in (H_x, H_y) plane, with two minima of energy from that with only one minimum*

Temperature dependence of the switching fields of a 3 nm Co cluster

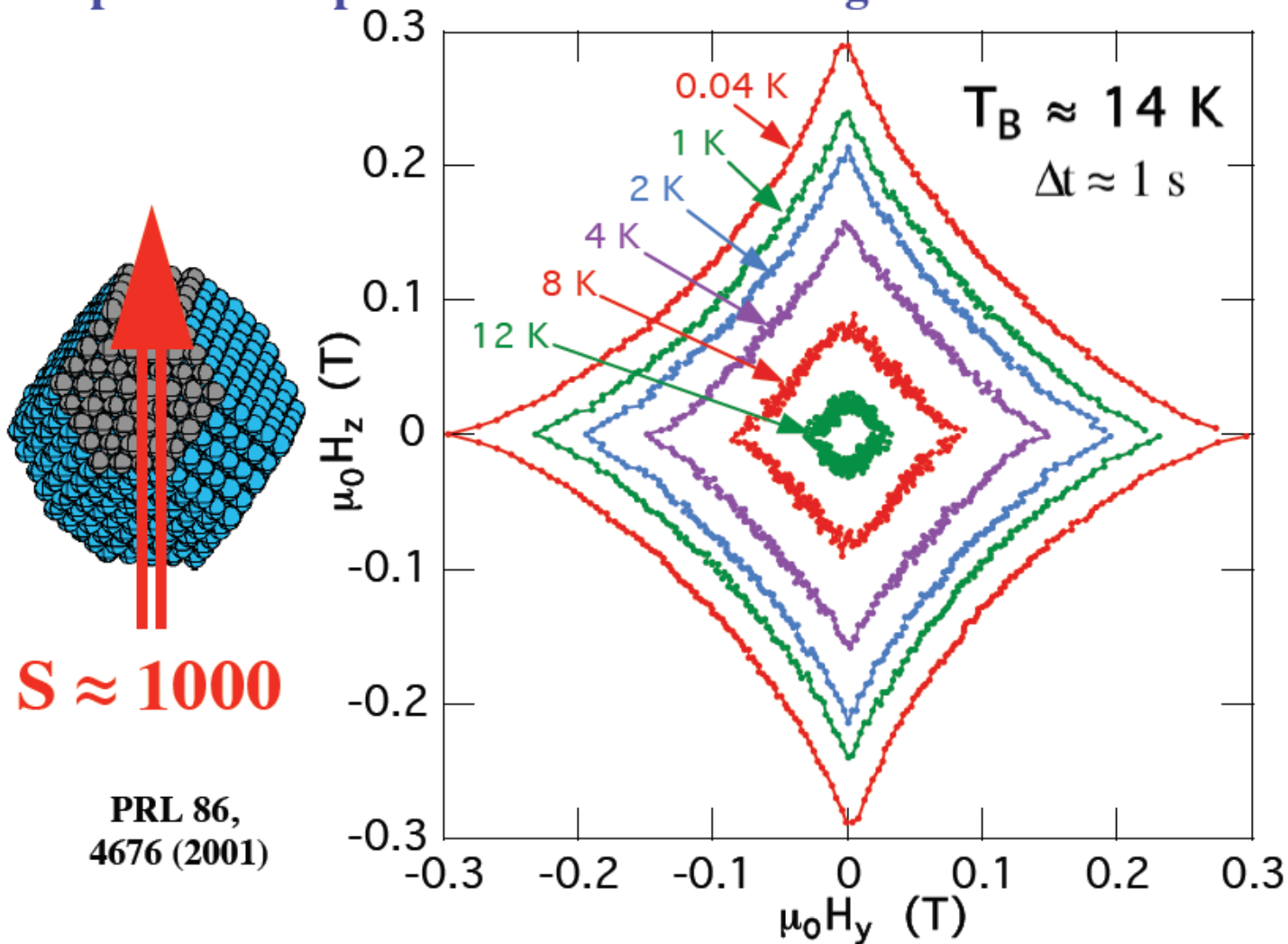

M. Jamet, W. Wernsdorfer, C. Thirion, D. Maily, V. Dupuis, P. Mélinon, and A. Pérez, Phys. Rev. Lett **86**, 4676 (2001)

Shape anisotropy

- Polycrystalline samples without a preferred orientation of the grains do not show, in macroscopic experiments, any magneto crystalline anisotropy [9].
- If the sample is not spherical the magnetostatic energy of the system depends on the orientation of magnetic moments within the sample (or macrospin in a simplified picture).
- The effect is of purely magnetostatic origin and is closely related to demagnetizing fields (see **lecture 2**):

If and only if the surface of uniformly magnetized body is of second order the magnetic induction inside is uniform and can be written as:

$$\vec{B} = \mu_0 (-N \cdot \vec{M} + \vec{M})$$

N is called the demagnetizing tensor [5]. If magnetization is parallel to one of principle axes of the ellipsoid N contracts to **three numbers** called demagnetizing (or demagnetization) factors sum of which is one:

$$N_x + N_y + N_z = 1$$

For a general ellipsoid magnetization and induction are not necessarily parallel.

Demagnetization decreases the field inside ferromagnetic body.

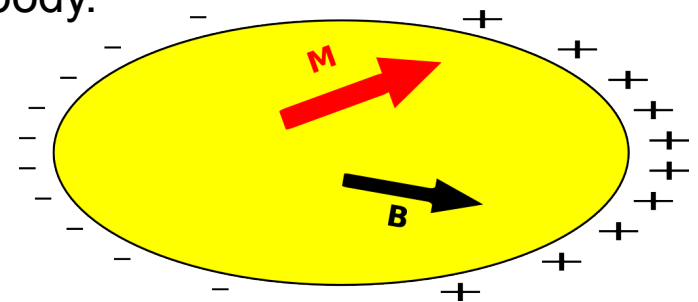

Shape anisotropy

- Polycrystalline samples without a preferred orientation of the grains do not show, in macroscopic experiments, any magneto crystalline anisotropy [9].
- If the sample is not spherical the magnetostatic energy of the system depends on the orientation of magnetic moments within the sample (or macrospin in a simplified picture).
- The effect is of purely magnetostatic origin and is closely related to demagnetizing fields.

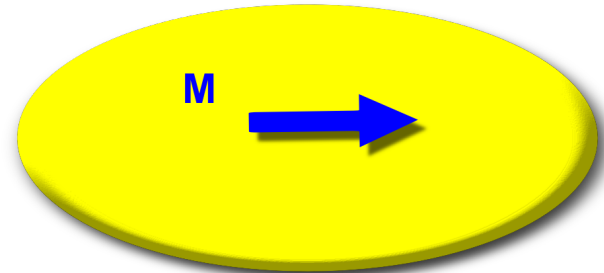
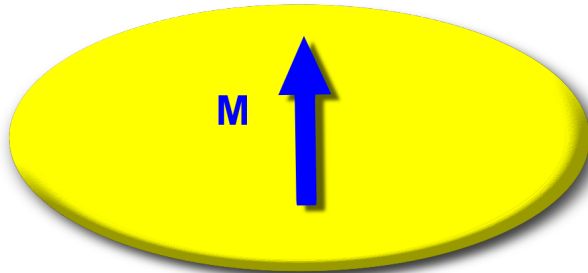

- The energy of the sample in its own stray field is given by the integral [9]:

$$E_{demag} = -\frac{1}{2} \int \vec{B}_{demag} \cdot \vec{M} dV = \frac{1}{2} \int \mu_0 (N \cdot \vec{M}) \cdot \vec{M} dV \quad \vec{B}_{demag} = -\mu_0 N \cdot \vec{M}$$

- If the sample is an ellipsoid the demagnetizing field is uniform throughout the sample:

$$E_{demag} = \frac{1}{2} V \mu_0 (N \cdot \vec{M}) \cdot \vec{M}, \quad V - \text{volume of the sample}$$

- N is a diagonal tensor if the semiaxes of the ellipsoid coincide with the axes of the coordination system.

Shape anisotropy

$$N_{\text{ellipsoid}} = \begin{bmatrix} N_a & 0 & 0 \\ 0 & N_b & 0 \\ 0 & 0 & N_c \end{bmatrix}$$

- For the general ellipsoid sample we have [9]:

$$E_{\text{demag}} = \frac{1}{2} V \mu_0 (N \cdot \vec{M}) \cdot \vec{M} = \frac{1}{2} \mu_0 M^2 (N_a \alpha_1^2 + N_b \alpha_2^2 + N_c \alpha_3^2) \quad \vec{M} = M (\alpha_1, \alpha_2, \alpha_3)$$

- For a spherical sample we have:

$$N = \begin{bmatrix} 1/3 & 0 & 0 \\ 0 & 1/3 & 0 \\ 0 & 0 & 1/3 \end{bmatrix} \Rightarrow E_{\text{demag}} = \frac{1}{2} \mu_0 M^2 \frac{1}{3} (\alpha_1^2 + \alpha_2^2 + \alpha_3^2) = \frac{1}{6} \mu_0 M^2 \quad \text{no dependence on the magnetic moment orientation}$$

- For an infinitely long cylinder* N_c is null: $(\alpha_1, \alpha_2, \alpha_3) = (\sin(\theta) \cos(\phi), \sin(\theta) \sin(\phi), \cos(\theta))$

$$N = \begin{bmatrix} 1/2 & 0 & 0 \\ 0 & 1/2 & 0 \\ 0 & 0 & 0 \end{bmatrix} \Rightarrow E_{\text{demag}} = \frac{1}{2} \mu_0 M^2 \frac{1}{2} (\alpha_1^2 + \alpha_2^2) = \frac{1}{2} \mu_0 M^2 \frac{1}{2} (\sin^2(\theta) \cos^2(\phi) + \sin^2(\theta) \sin^2(\phi)^2) =$$

$$E_{\text{demag}} = \frac{1}{4} \mu_0 M^2 \sin^2(\theta)$$

Uniaxial anisotropy-
characteristic for elongated
particles (see Stoner-
Wohlfarth model)

*polar axis is a symmetry axis

Shape anisotropy

- For infinitely expanded and/or very thin ellipsoid we have [9]:

$$N = \begin{bmatrix} 0 & 0 & 0 \\ 0 & 0 & 0 \\ 0 & 0 & 1 \end{bmatrix} \Rightarrow E_{demag} = \frac{1}{2} \mu_0 M^2 \alpha_3^2 = \frac{1}{2} \mu_0 M^2 \cos^2(\theta)$$

The in-plane orientation of magnetic moment of thin plate is energetically favorable*

- The equation can be rewritten to often used form:

$$E_{demag} = \frac{1}{2} \mu_0 M^2 (1 - \sin^2(\theta)) = \frac{1}{2} \mu_0 M^2 - \frac{1}{2} \mu_0 M^2 \sin^2(\theta) = K_0 + K_{shape}^V \sin^2(\theta),$$

with $K_{shape}^V = -\frac{1}{2} \mu_0 M^2$

- Magnetocrystalline and shape anisotropy constants for thin films of elements at 4 K**:

	Fe (bcc)	Co (hcp)	Ni (fcc)
K_1 [J/m ³]	54 800	760 000	-126 300
K^V [J/m ³]	1 910 000	1 290 000	171 000

Shape anisotropy in thin films usually dominates over magnetocrystalline anisotropy

*in case magnetocrystalline anisotropy is absent

**magnetization data from: Francois Cardelli Materials Handbook, Springer 2008 (p.502), <http://books.google.pl>

Shape anisotropy

- From Stoner-Wohlfarth model we have: $B_S = \frac{2K_1}{M}$
- Substituting the expression for shape anisotropy of thin films $K_{shape}^V = -\frac{1}{2}\mu_0 M^2$ we get:
 $B_S = \mu_0 M_S$ or $H_S = M_S$

In macrospin approximation the perpendicular saturation field of thin film is equal to its magnetization.

Shape anisotropy – purely magnetostatic interactions

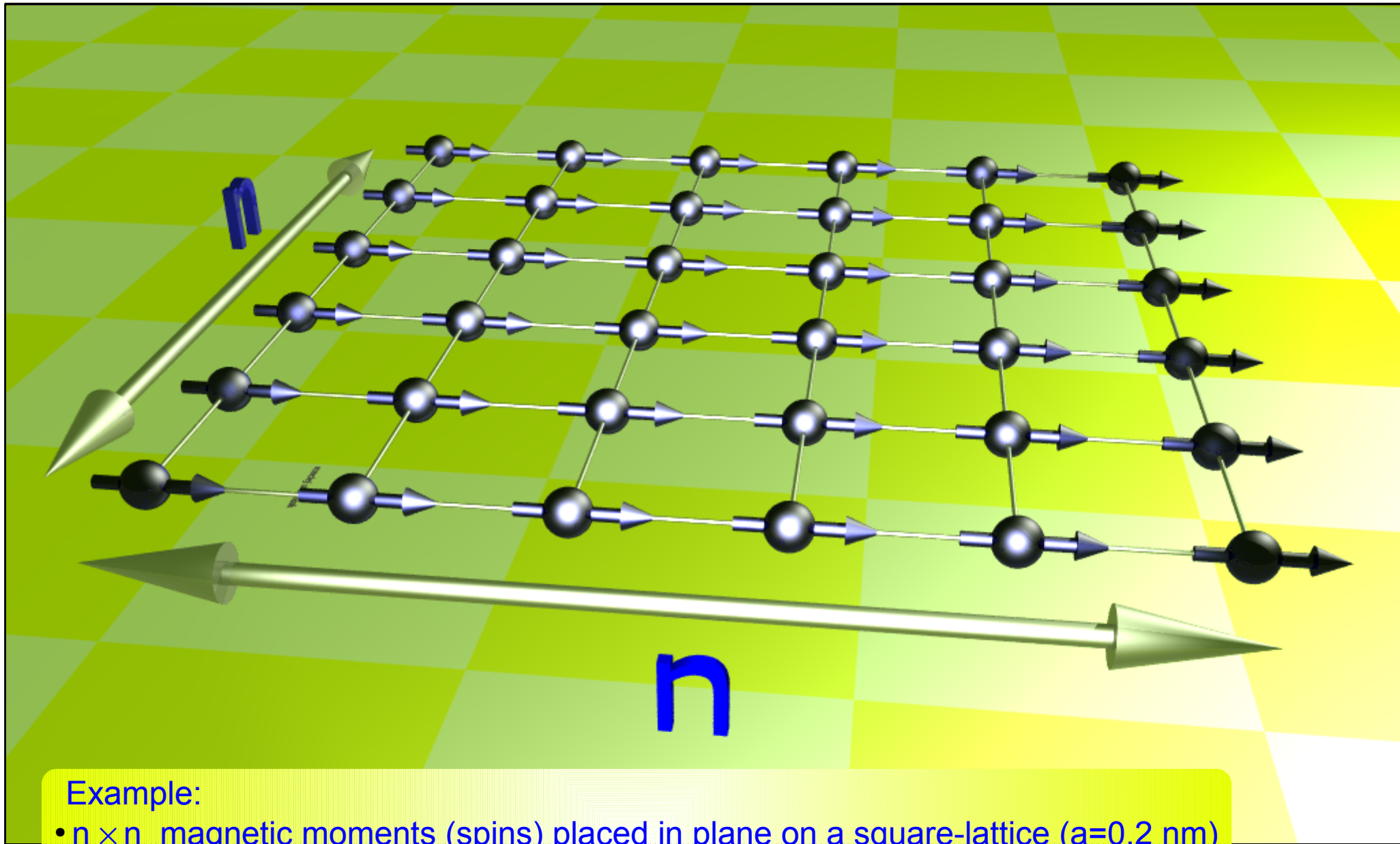

Example:

- $n \times n$ magnetic moments (spins) placed in plane on a square-lattice ($a=0.2$ nm)
- magnetic moments interact purely magnetostatically
- each moment is a 1 bohr magneton ($\approx 1 \times 10^{-24}$ Am²)

Shape anisotropy – purely magnetostatic interactions

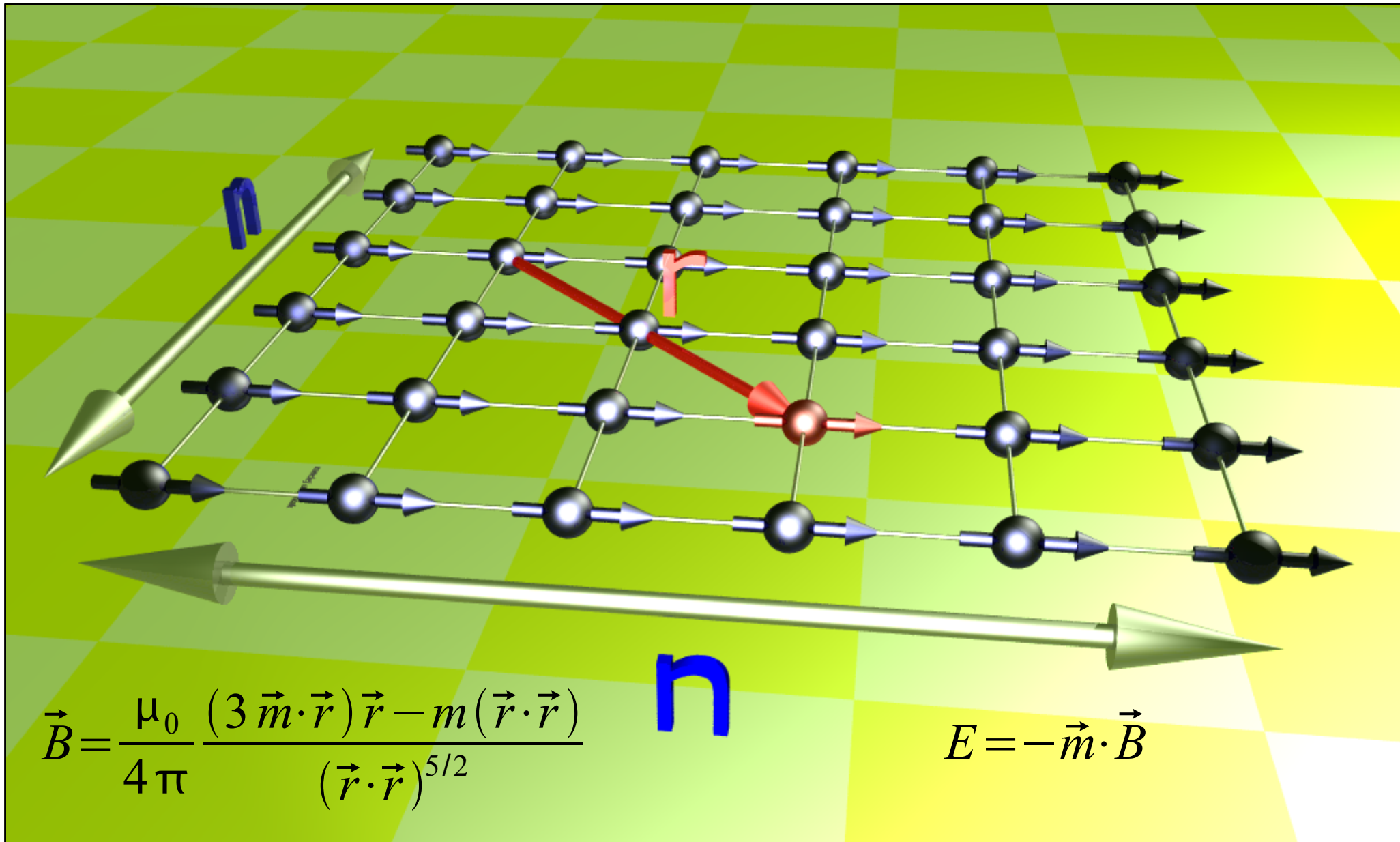

Shape anisotropy – purely magnetostatic interactions

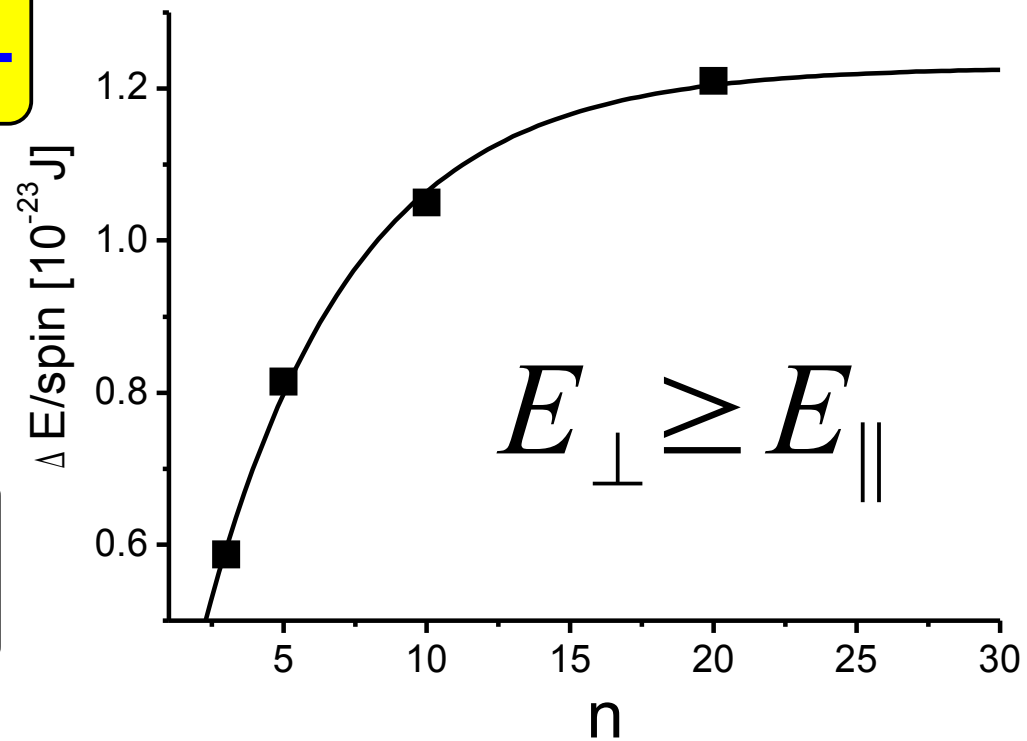
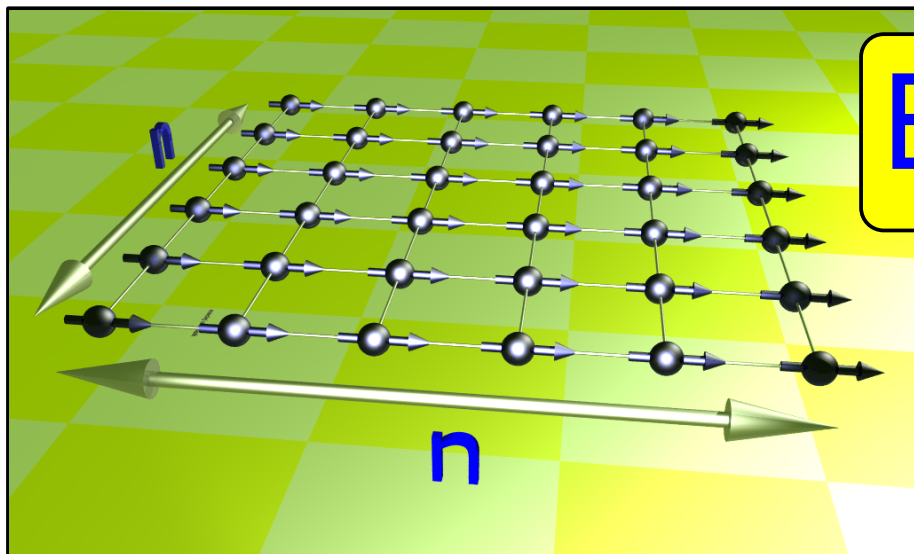
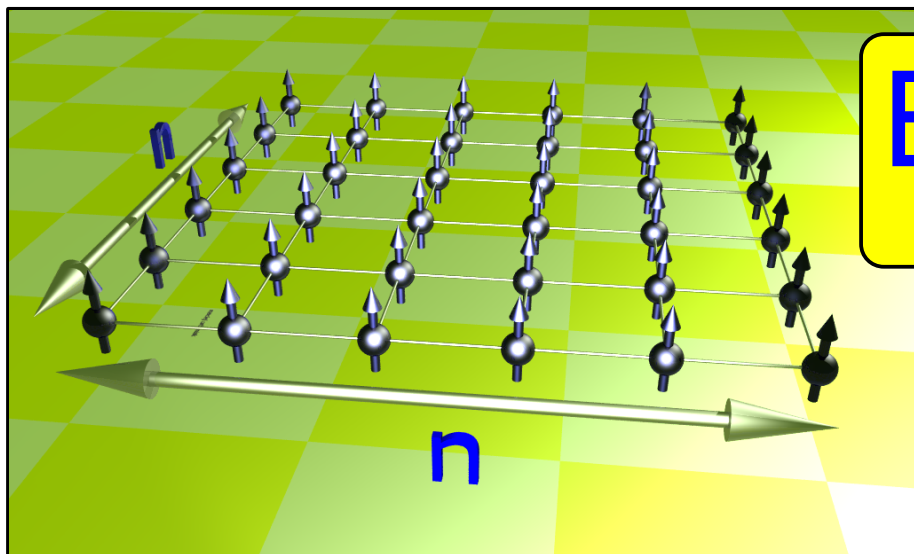

Magnetostatic interactions favor in-plane orientation of magnetic moments (spins) in thin magnetic films

Surface anisotropy – reorientation phase transition

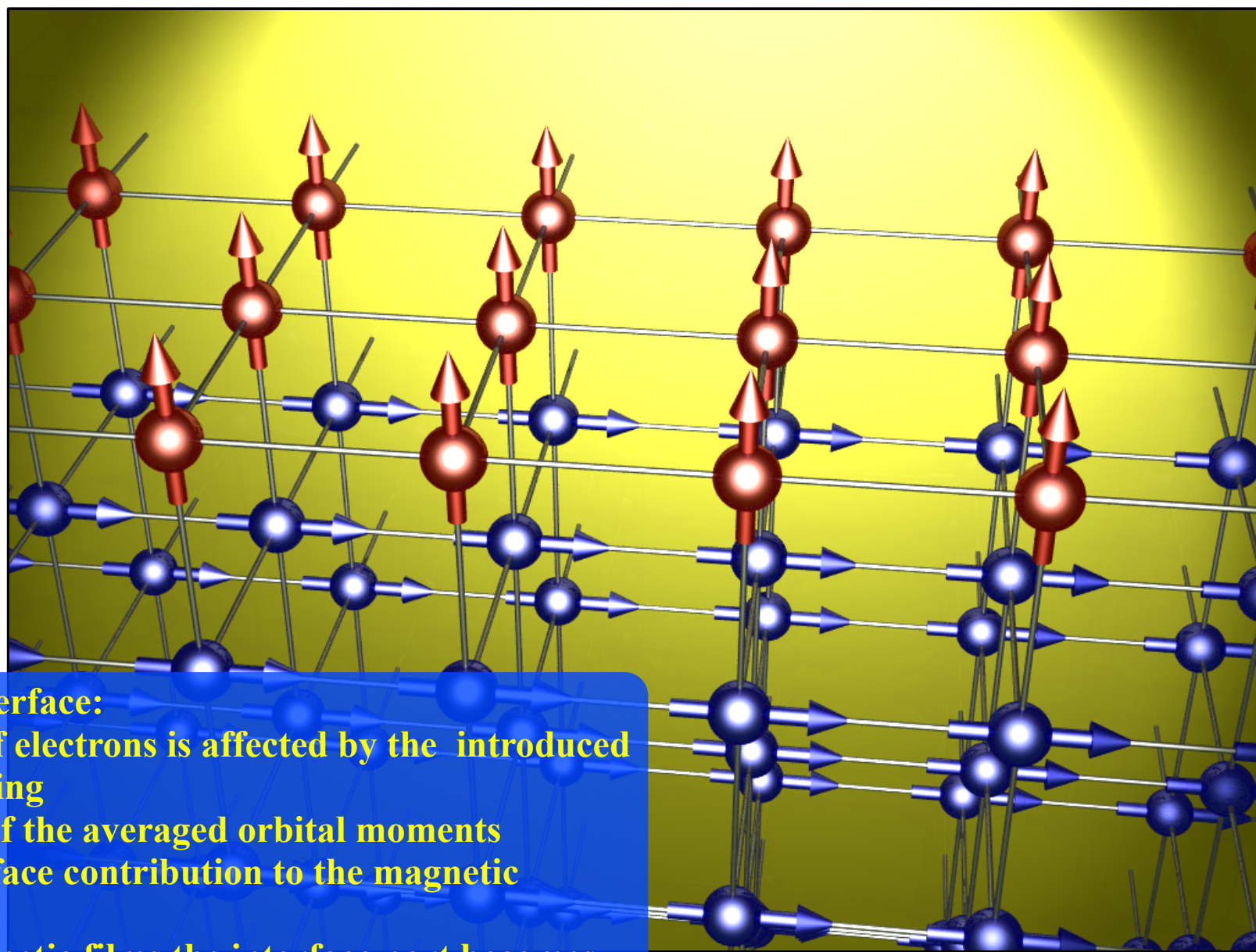

presence of an interface:

- orbital motion of electrons is affected by the introduced symmetry breaking
- the asymmetry of the averaged orbital moments defines the interface contribution to the magnetic anisotropy
- in ultrathin magnetic films the interface part becomes even dominating in some cases

A.Stupakiewicz et al., PRB 80, 094423 (2009)

Surface anisotropy – reorientation phase transition

- Due to broken symmetry at interfaces the anisotropy energy contains terms with lower order in direction cosines than in the infinite crystal.

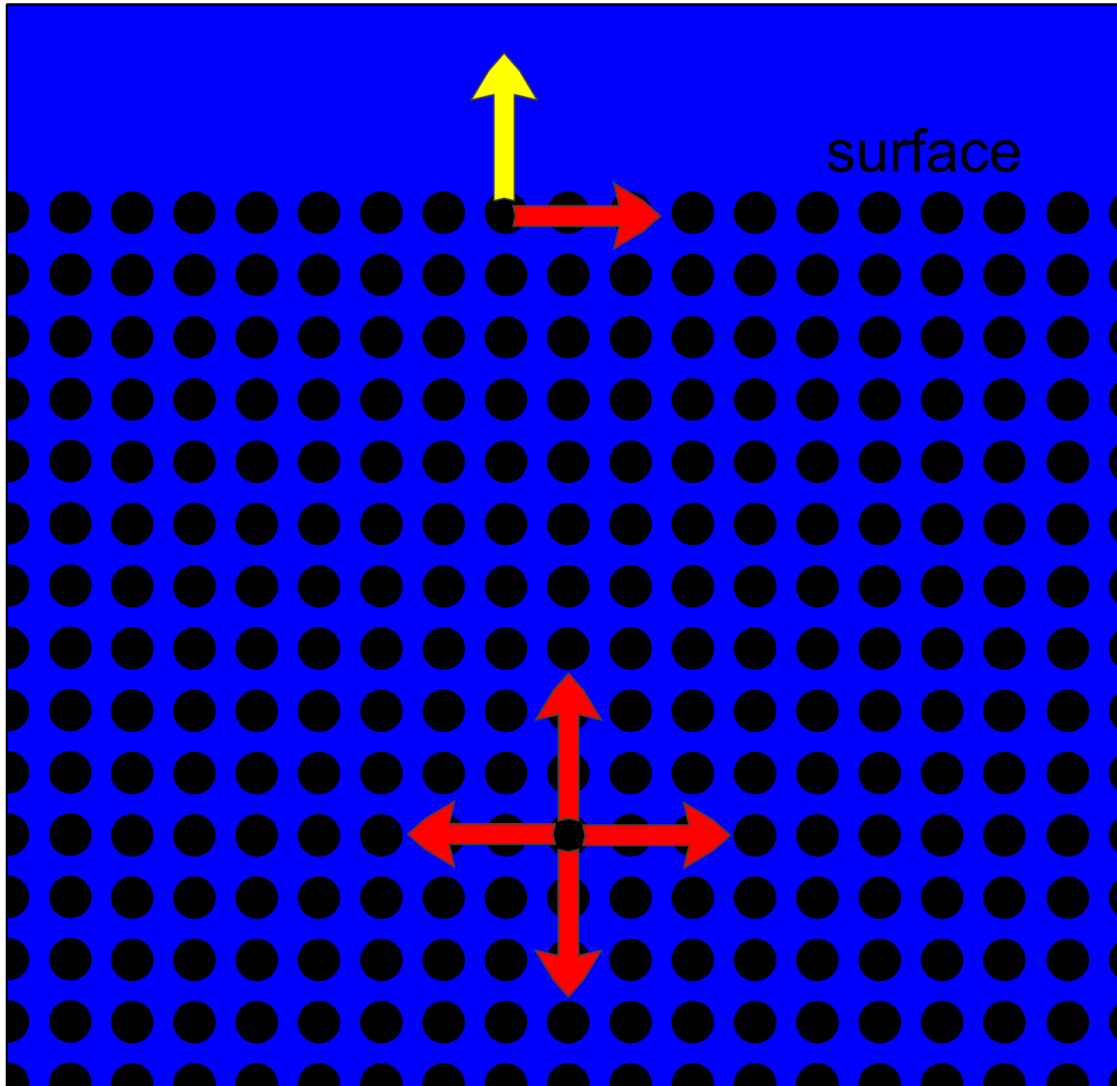

- Energy of magnetic moments of atoms occupying lattice sites in the vicinity of the surface is different for two shown orientations
- Each of the magnetocrystalline anisotropy constants can be phenomenologically divided into two parts, one related to volume contribution and the one to surface contribution [9]:

$$K^{eff} = K^v + K^s / t$$

where t is the crystal thickness.

-
- Energy of magnetic moments of atoms occupying lattice sites far from the outer boundary of the crystal depends on the intrinsic symmetry of the crystal

Surface anisotropy – reorientation phase transition

•Let us assume that volume contribution to the anisotropy favors in-plane alignment of magnetic moments (it could be magnetocrystalline, shape, stress etc. anisotropy).

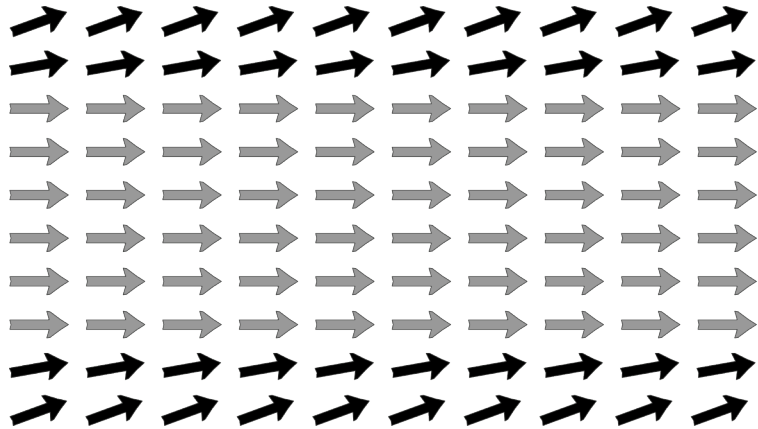

•Due to perpendicular surface anisotropy the moments close to the surface (black arrows) are deflected out of plane

•If the thickness of the sample/film is high the exchange coupling of the surface moments with the bulk ones keeps the overall moment of the sample nearly in plane

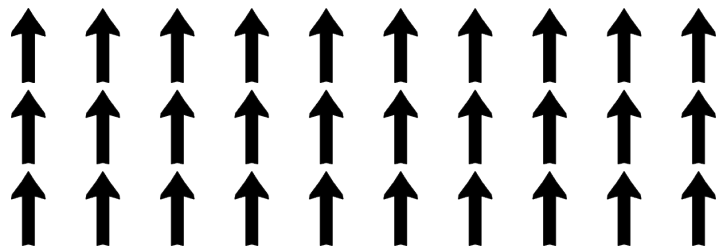

•If the thickness of the film is low, and the surface anisotropy is strong enough all moments point perpendicular to plane.

•Using macrospin approximation the total energy of the sample dependent on the orientation of magnetic moment can be written as [10] (we assume that the energy does not depend on azimuthal angle):

$$E_a = K_0 - K_2 \cos^2(\theta) - K_4 \cos^4(\theta) + \dots \quad *$$

-positive K_i favor perpendicular orientation

*different notations of anisotropy constants can be encountered: R. Skomski et. al, Phys. Rev. B 58, 11138 (1998)

Surface anisotropy – reorientation phase transition

•Minimizing E_a with respect to θ yields the equilibrium angle:

$$\partial^2 E_a / \partial \theta^2 = 2 K_2 \cos(\theta) \sin(\theta) + 4 K_4 \cos^3(\theta) \sin(\theta) = 0 \Rightarrow \cos(\theta) \sin(\theta) (2 K_2 + 4 K_4 \cos^2(\theta)) = 0$$

•We have extrema for:

$$\theta = 0, \pi/2, \cos^2(\theta) = \frac{-K_2}{2 K_4}$$

•It can be shown that [10]:

-for $K_2 > 0$ and $K_4 > 0$ the magnetization is perpendicular to the plane

-for $K_2 > 0$ and $2K_4 < -K_2$ the canted magnetization is a ground state

-the region for $K_2 < 0$ and $2K_4 > -K_2$ is called a *coexistence region* – both perpendicular and in-plane orientations of magnetization correspond to local minimum; they are separated by energy barrier

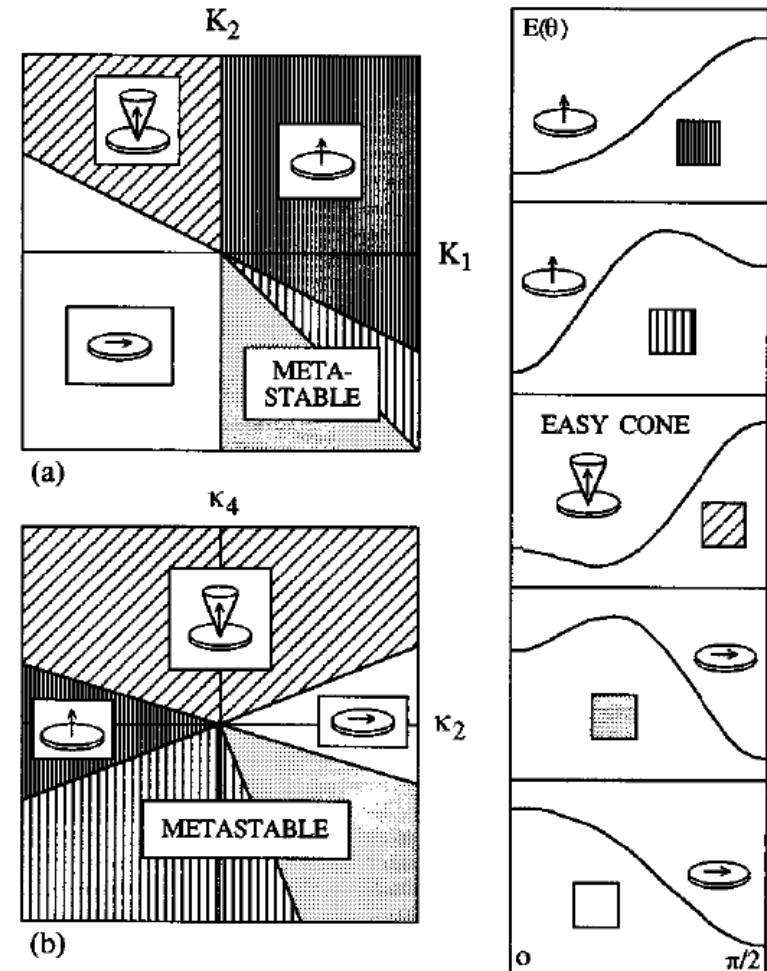

FIG. 2. Basic uniaxial phase diagrams from which the present calculations start: (a) in K_1 - K_2 representation and (b) in κ_2 - κ_4 representation. Note that $H=0$ and $E_a(\theta) = E_a(\pi - \theta)$.

Surface anisotropy – reorientation phase transition

- Recalling the presence of surface anisotropy terms we get:

$$E_a = K_0 - (K_2^v + K_2^s/t) \cos^2(\theta) - (K_4^v + K_4^s/t) \cos^4(\theta) + \dots$$

each anisotropy constant is divided into bulk (volume) and surface term

- Neglecting higher order terms we get the sample thickness for which the effective anisotropy is zero (neglecting constant K_0):

$$t_{RPT} = -\frac{K_2^s}{K_2^v}$$

- Usually, when considering thin films, the sample has two surfaces contributing surface anisotropy. As a consequence the multiplier 2 is added*:

$$t_{RPT} = -\frac{2K_2^s}{K_2^v}$$

RPT – reorientation phase transition
SRT -spin reorientation transition

- For film thickness $> t_{RPT}$ the magnetization of the film lies in-plane (if the external field is absent).
- RPT may be caused by:
 - temperature change
 - change of the thickness of magnetic layer
 - change of the thickness of the overlayer

*in general both surfaces can be characterized by different surface anisotropy constants.

Surface anisotropy – reorientation phase transition

•From the expression with surface anisotropy we have:

$$K_{eff} = K_2^v + 2 K_2^s / t$$

$$K_{eff} t = K_2^v t + 2 K_2^s$$

•Plotting $K_{eff} t$ vs t one can determine volume and surface contributions to anisotropy with a linear fit:

- K_V - slope

- K_S – $K_{eff} \cdot t$ ($t=0$)

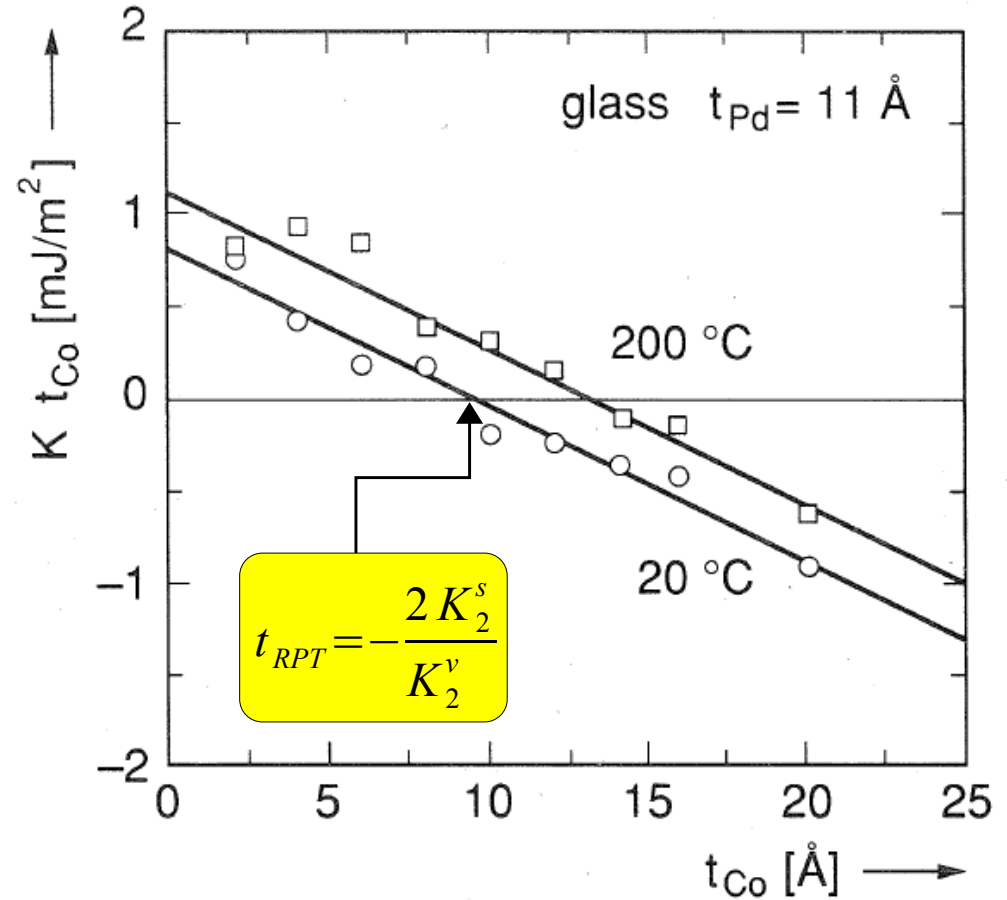
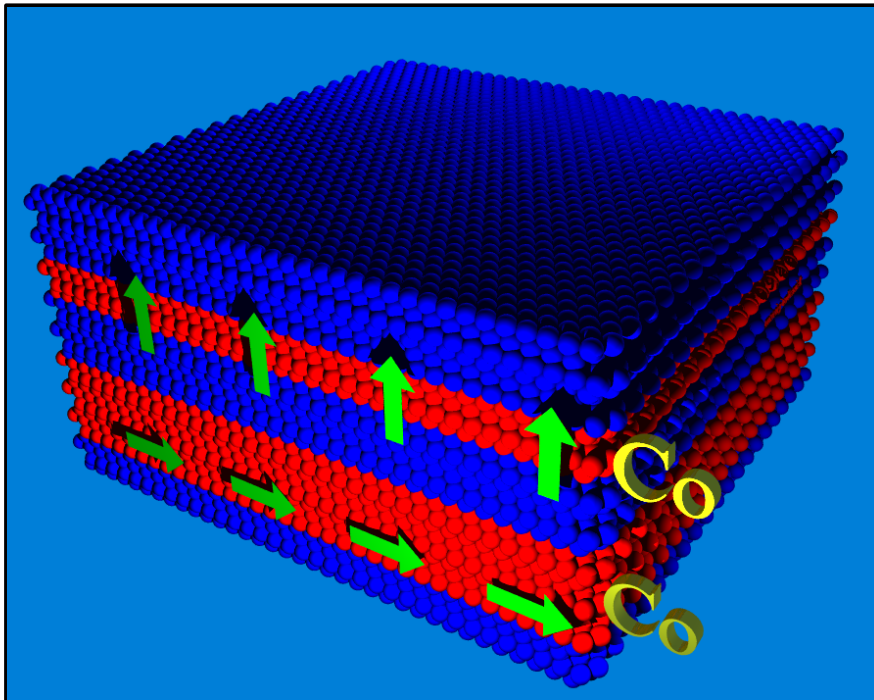

Fig. 2. Dependence of $K t_{Co}$ on t_{Co} for polycrystalline Co/Pd multilayers, deposited at $T_s = 20$ and 200°C .

Surface anisotropy – reorientation phase transition

- RPT may be caused by:
 - temperature change
 - change of the thickness of magnetic layer
 - change of the thickness of the overlayer

$$K^{eff} = K^v + 2K^s/t$$

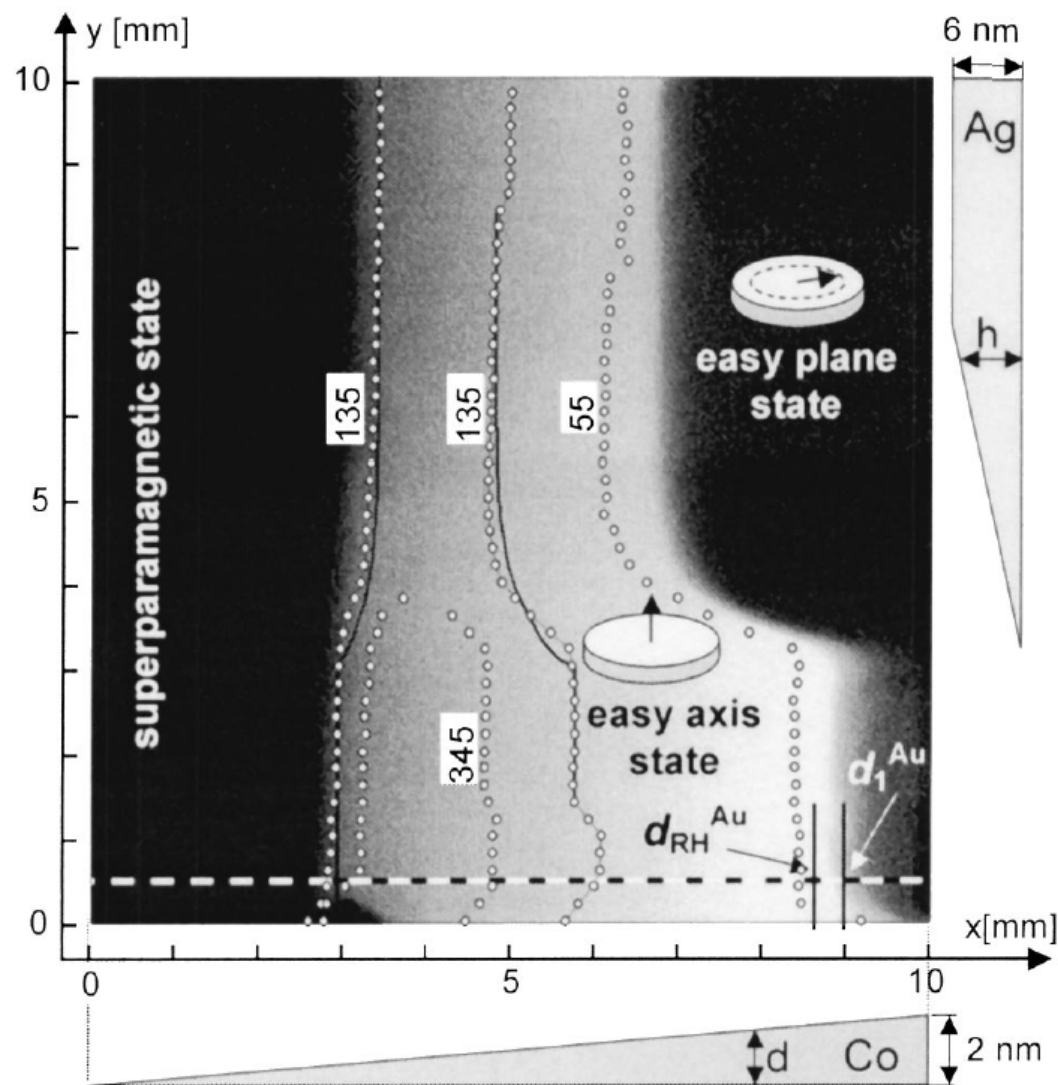

FIG. 1. Cobalt wedge remnant state image $P(i,j)$ determined for a fully saturated sample in both $H_{\perp} > 0$ and $H_{\perp} < 0$ directions. On the basis of magnetometric analysis, localization of different magnetization states is marked. Points show the coercivity wall positions registered for different H_{\perp} field pulse ($\Delta = 900$ ms) magnitudes (measured in Oe). Solid black lines have been fitted to the coercivity wall data, registered at $H_{\perp} = 135$ Oe, using $H_C(x,y)$ function with $h_C^* = 0.8$ nm as the best fitting parameter. Below the horizontal dashed line in the gold region growth imperfections are clearly visible.

Kisielewski et al., J. Appl. Phys. 93, 7629 (2003)

Surface anisotropy – reorientation phase transition

- RPT may be caused by:
 - temperature change
 - change of the thickness of magnetic layer
 - change of the thickness of the overlayer

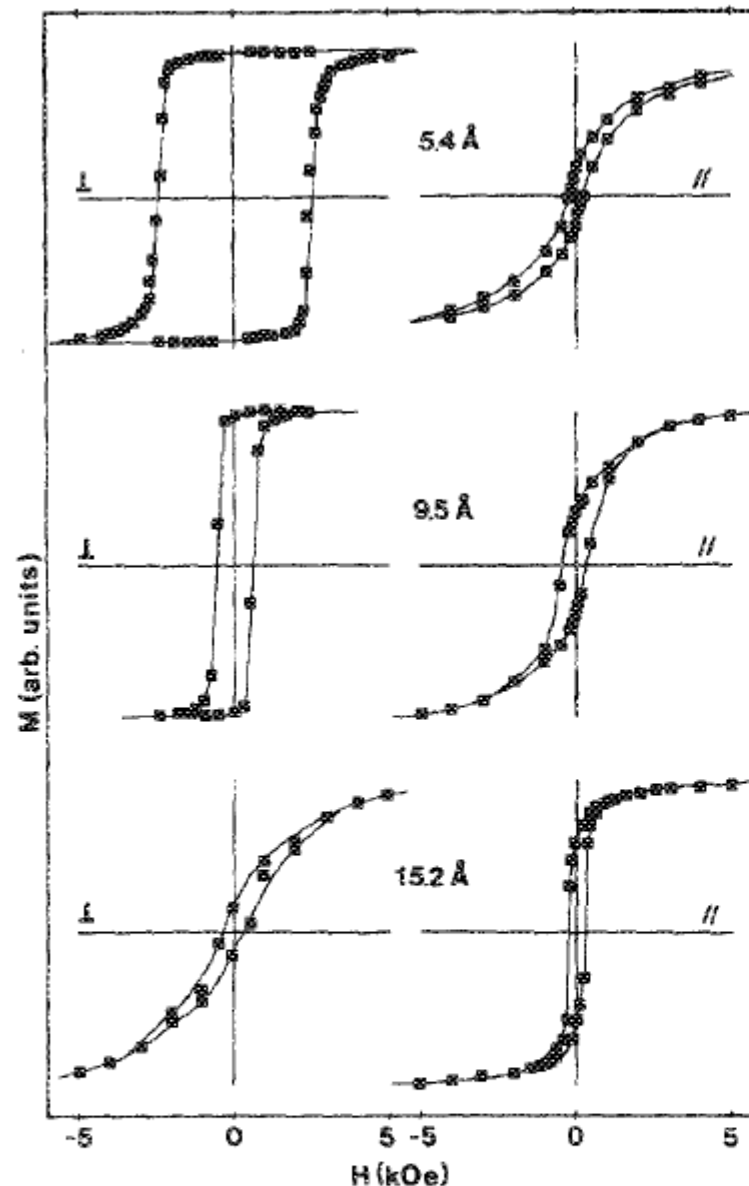

FIG. 4. Hysteresis loop with H perpendicular (\perp) and parallel (\parallel) to the film plane, for Au/Co/Au sandwiches with $t = 5.4, 9.5,$ and 15.4 \AA , at $T = 10 \text{ K}$.

Image source: C. Chappert, P. Bruno, J. Appl. Phys. 64, 5736 (1988)

Stress anisotropy and magnetostriction

- Magnetostriction is a change of materials physical dimensions as a result of the change of the orientation of magnetization
- The direction of magnetization changes under the influence of external field or temperature.

The relative deformation is usually small; of the order of 10^{-6} to 10^{-5} [6]; in Tb λ is approx. 0.002 at RT.

- The typical strain versus field dependence shows saturation which is expressed by the value of magnetostriction constants λ :

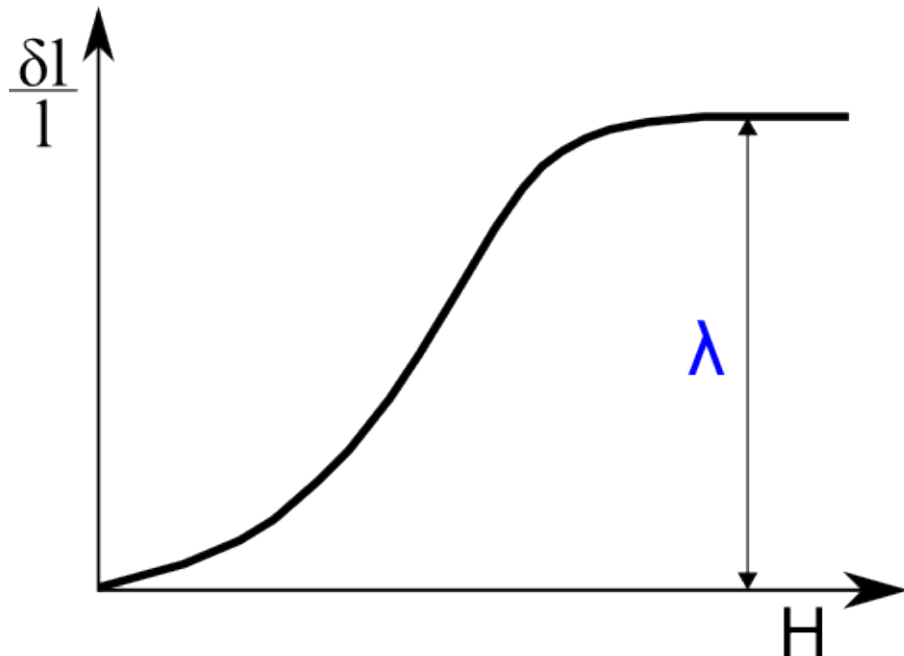

- In giant magnetostriction materials the strain exceeds 0.5%

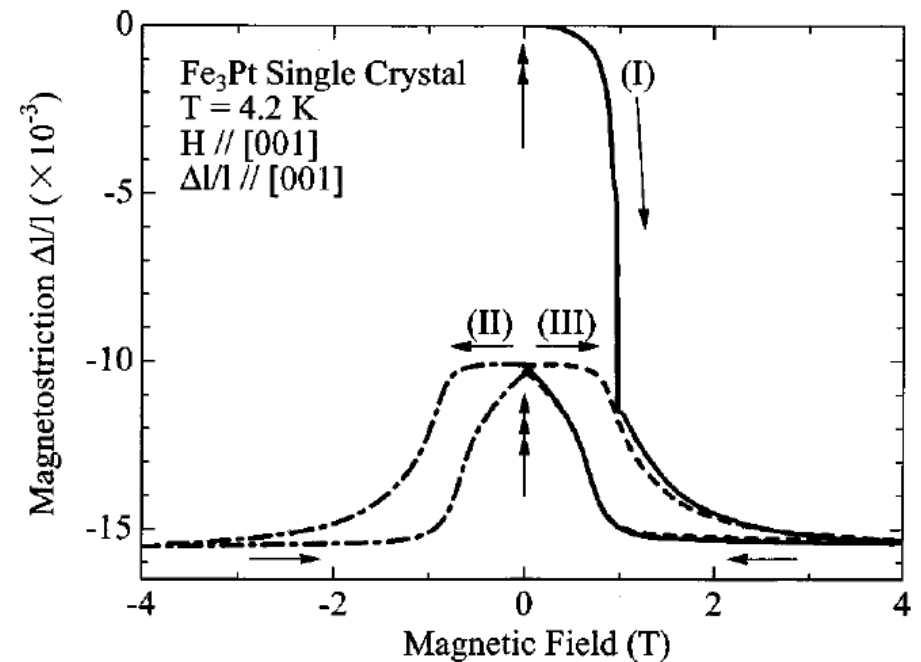

FIG. 4. Magnetostriction of an ordered Fe_3Pt . Strain of 1.5×10^{-2} is obtained by application of a magnetic field of 4 T, which is indicated by (I). The total strain comes to about 2.0×10^{-2} including the strain due to the thermally induced martensitic transformation shown in Fig. 3. The reversible strain is 5×10^{-3} by applying and removing the magnetic field, which is indicated by (II) and (III).

Stress anisotropy and magnetostriction

- Magnetostriction is a change of materials physical dimensions as a result of the change of the orientation of magnetization
- The direction of magnetization changes under the influence of external field or temperature.

The relative deformation is usually small; of the order of 10^{-6} to 10^{-5} [6]; in Tb λ is approx. 0.002 at RT.

- The typical strain versus field dependence shows saturation which is expressed by the value of magnetostriction constants λ :

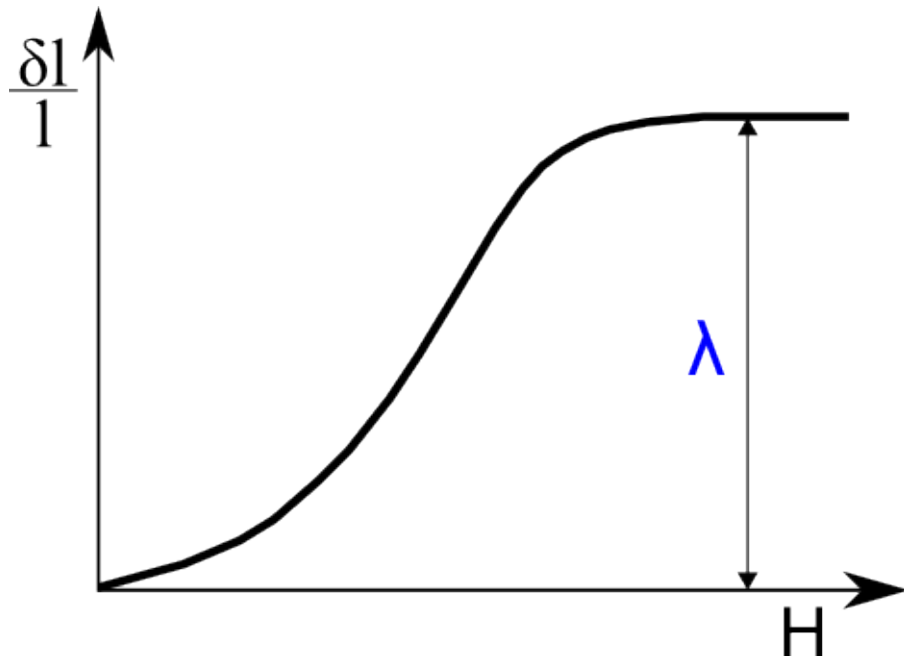

- The dependence $dI/I(H)$ is different for different orientations of applied field relative to crystal axes



Abb. 186. Sättigungsmagnetostriction von Einkristallen der Nickel-Eisen-Legierungen zwischen 30% und 100% Nickel für die drei kristallographischen Hauptrichtungen. [Nach F. LICHTENBERGER: Ann. Phys., Lpz. V, Bd. 10 (1932) S. 45.]

Stress anisotropy and magnetostriction

- In most practical applications the saturation distortion can be described by expression with small number of constants [11]:

$$\lambda = \frac{3}{2} \lambda_{100} (\alpha_1^2 \beta_1^2 + \alpha_2^2 \beta_2^2 + \alpha_3^2 \beta_3^2 - \frac{1}{3}) + 3 \lambda_{111} (\alpha_1 \alpha_2 \beta_1 \beta_2 + \alpha_2 \alpha_3 \beta_2 \beta_3 + \alpha_3 \alpha_1 \beta_3 \beta_1),$$

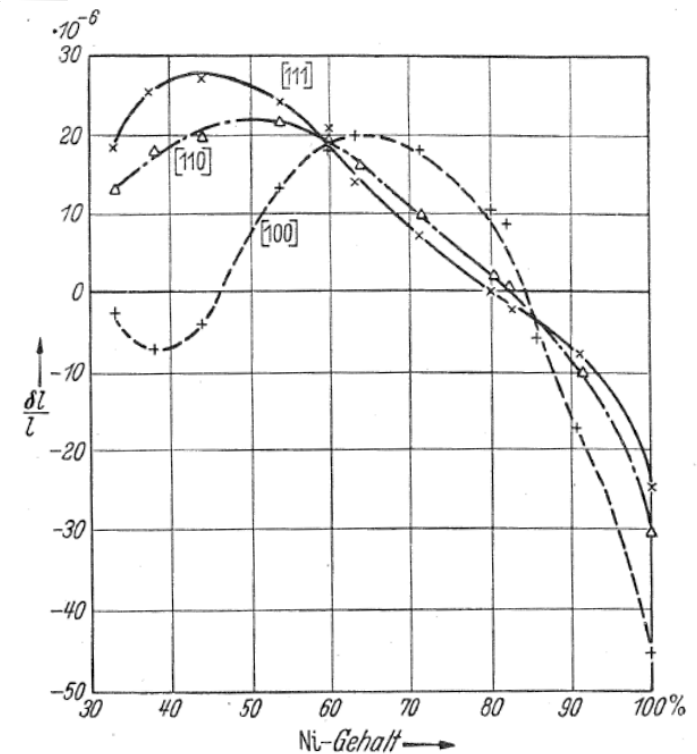
where $\alpha_1, \alpha_2, \alpha_3$ – direction cosines of magnetic moment direction; $\beta_1, \beta_2, \beta_3$ – direction cosines of the direction along which the deformation is measured.

- In amorphous and polycrystalline materials (without the texture) the above expression simplifies to:

$$\lambda = \frac{3}{2} \lambda_s (\cos^2 \theta - \frac{1}{3})$$

- Distortion along the external magnetic field direction is twice that observed for plane perpendicular to the field (see the drawing →)
- Below Curie temperature the spontaneous magnetization leads to **spontaneous distortion of lattice** [9]: cubic cell deforms to tetragonal system

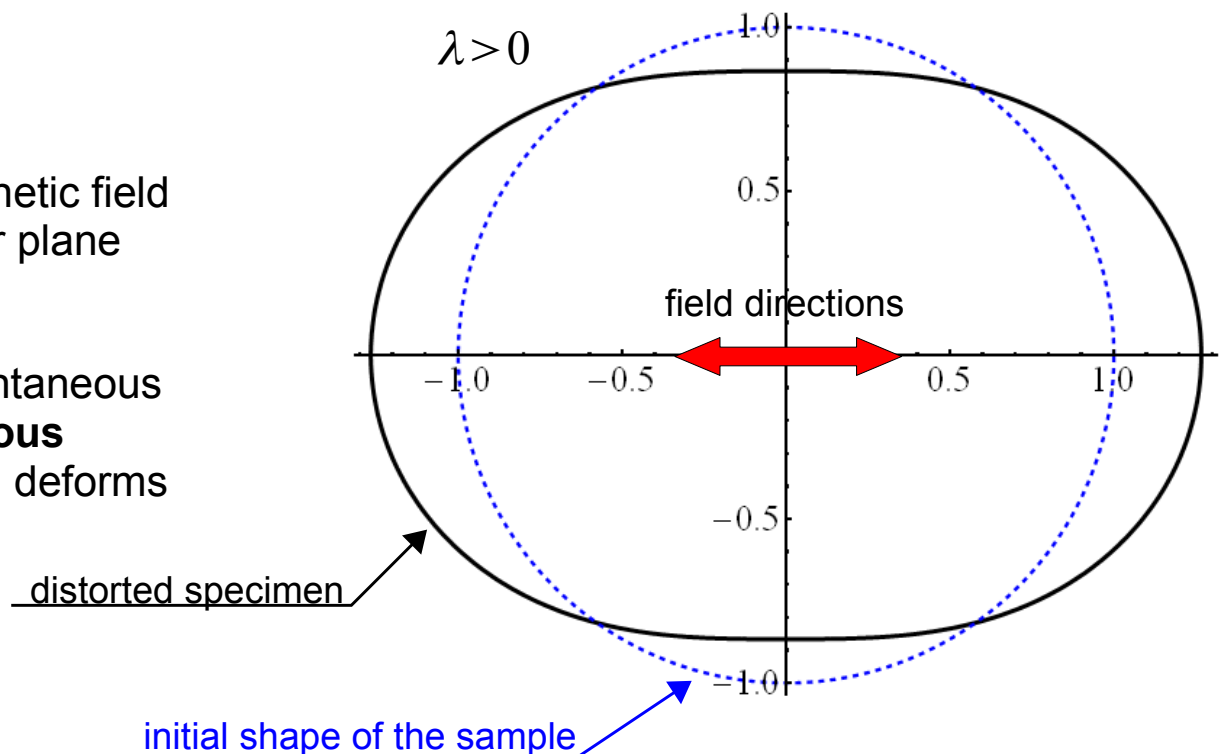

PolarPlot[{1+0.4 (Cos[t]^2-(1/3)),1},{t,0,2 Pi}]

Stress anisotropy – magnetomechanical effect*

- Stress applied to a ferromagnetic body will affect the orientation of magnetization through magnetostriction [6].
- The applied stress changes the magnetization reversal characteristics:

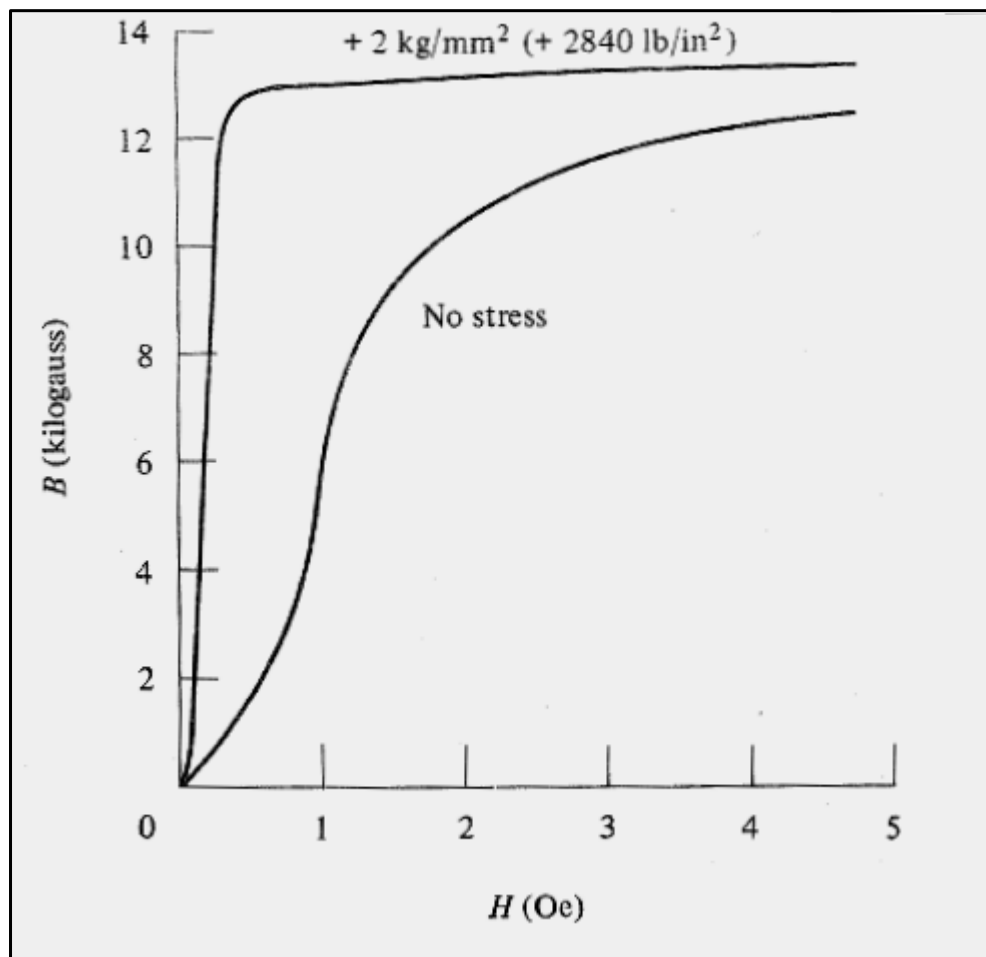

Fig. 8.16 Effect of applied tensile stress on the magnetization of 68 Permalloy. After Bozorth [G.4].

*called inverse magnetostrictive effect, too

Stress anisotropy – magnetomechanical effect

- The part of the energy of a cubic crystal depending on magnetic moment orientation and the stress applied to crystal can be shown to be [3]:

$$E = K_1(\alpha_1^2\alpha_2^2 + \alpha_2^2\alpha_3^2 + \alpha_3^2\alpha_1^2) + \dots - \frac{3}{2}\lambda_{100}\sigma(\alpha_1^2\gamma_1^2 + \alpha_2^2\gamma_2^2 + \alpha_3^2\gamma_3^2) - 3\lambda_{111}\sigma(\alpha_1\alpha_2\gamma_1\gamma_2 + \alpha_2\alpha_3\gamma_2\gamma_3 + \alpha_3\alpha_1\gamma_3\gamma_1),$$

$\gamma_1, \gamma_2, \gamma_3$ - direction cosines of the external stress σ

magnetocrystalline anisotropy

- When the magnetostriction is isotropic ($\lambda_{100} = \lambda_{111} = \lambda_{si}$) the last two terms reduce to*:

$$E_{stress} = -\frac{3}{2}\lambda_{si}\sigma\cos^2\theta,$$

where θ is the angle between macrospin (magnetization) and the stress directions

- The effect of stress on isotropic sample depends on the sign of the $\lambda_{si}\sigma$ product
- The effect of stress is to introduce additional anisotropy to the ferromagnetic system

*with $(\alpha_1, \alpha_2, \alpha_3) = (\sin(\theta)\cos(\phi), \sin(\theta)\sin(\phi), \cos(\theta))$

Stress anisotropy – magnetomechanical effect

- The effect of the stress on magnetization reversal for positive $\lambda_{si}\sigma$ product [3]:
 - 1) the magnetic moments within the specimen point in one of four easy directions
 - 2) the application of tensile stress causes domains with magnetic moment perpendicular to the stress to dwindle
 - 3) still higher stress leaves only magnetic moments parallel to the stress
 - 4) Application of the weak magnetic field is sufficient to move 180 Deg domain wall and saturate the specimen

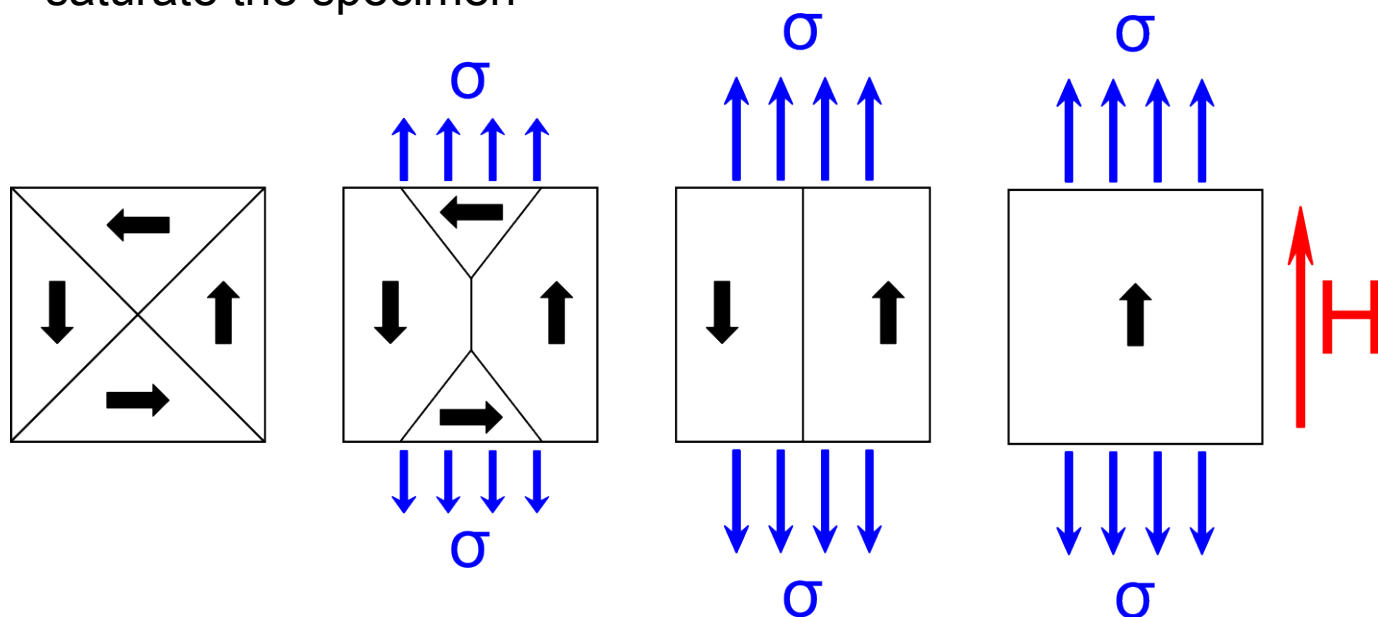

- If compressive stress was applied instead “vertical domains” would disappear and the field would initially (for small H) be perpendicular to magnetic moments.
- In Ni samples the stress of 6.4×10^6 Pa [3] causes stress anisotropy to be roughly equal to magnetocrystalline anisotropy.

Exchange anisotropy (exchange bias)

- Exchange bias occurs when ferromagnet and antiferromagnet are coupled by exchange interaction between magnetic moments on the common interface [3,7,12].
- The bias manifests itself as a shift of hysteresis loop along the field axis.

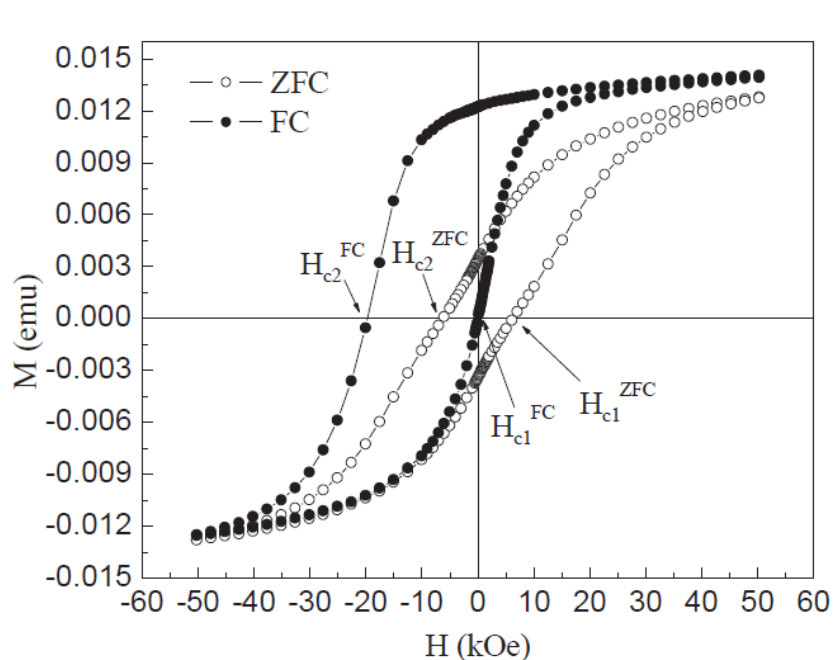
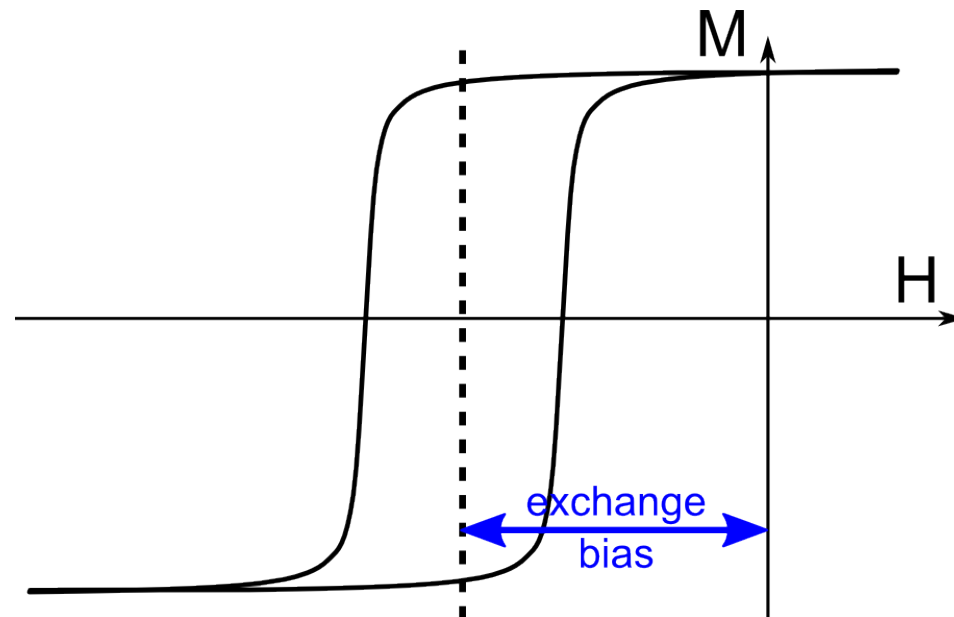

Fig. 4. Hysteresis loops measured at 6 K after ZFC and FC processes.



20nm diameter Co particles covered by
~3 nm of CoO antiferromagnet

Exchange anisotropy (exchange bias)

- Exchange bias occurs when ferromagnet and antiferromagnet are coupled by exchange interaction between magnetic moments on the common interface [3,7,12].
- The bias manifests itself as a shift of hysteresis loop along the field axis (or higher H_c [12]).

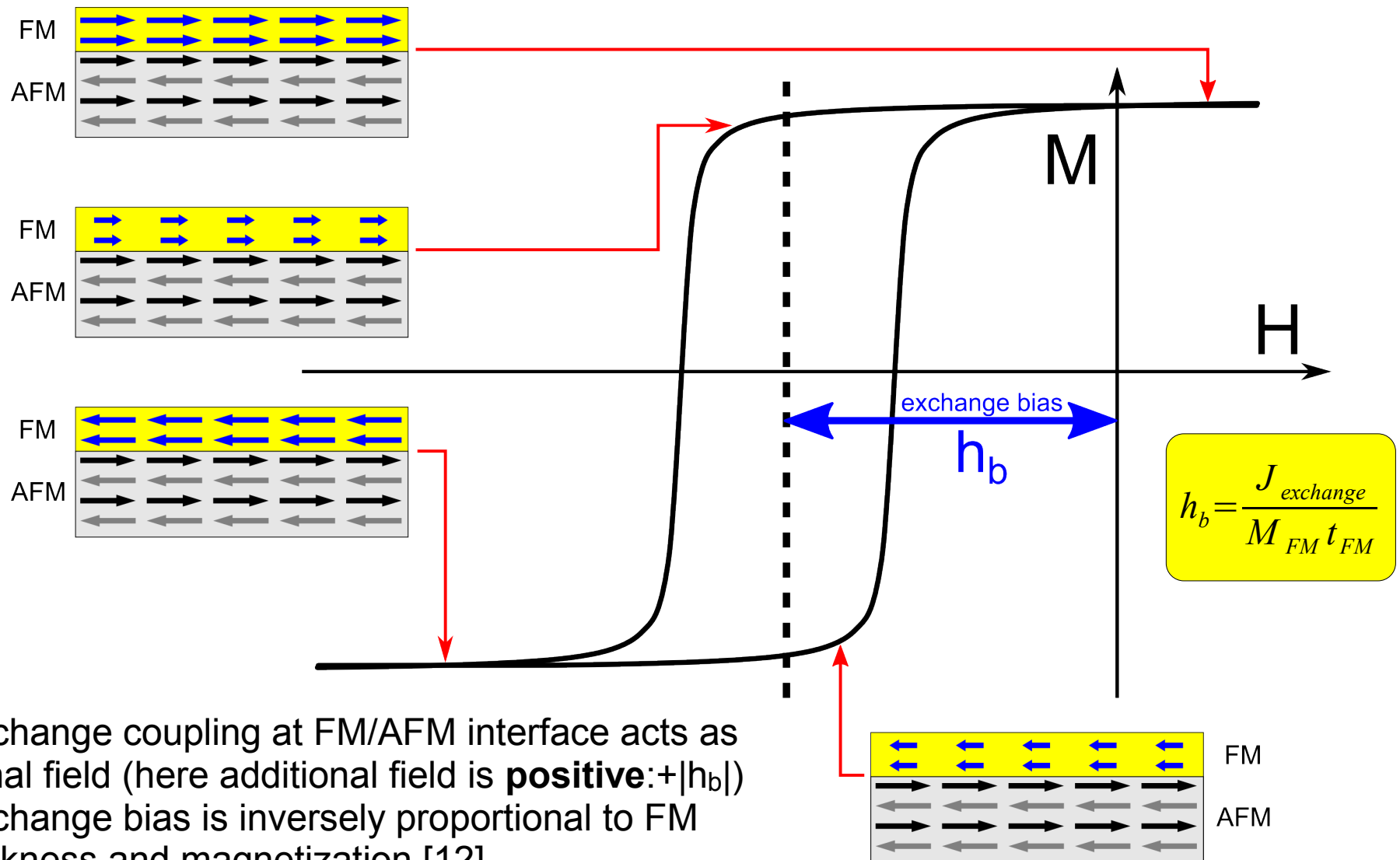

- The exchange coupling at FM/AFM interface acts as additional field (here additional field is **positive**: $+|h_b|$)
- The exchange bias is inversely proportional to FM film thickness and magnetization [12]

Bibliography:

- [1] S. Blügel, Magnetische Anisotropie und Magnetostriktion, Schriften des Forschungszentrums Jülich ISBN 3-89336-235-5, 1999
- [2] A. Aharoni, Introduction to the Theory of Ferromagnetism, Clarendon Press, Oxford 1996
- [3] B. D. Cullity, Introduction to magnetic materials, Addison-Wesley, Reading, Massachusetts 1972
- [4] A.P. Cracknell, Magnetyzm Kryształów, PWN Warszawa 1982
- [5] R.M. Bozorth, Ferromagnetism, D.van Nostrand Company, 1951
- [6] S. Chikazumi, Physics of Magnetism, John Wiley & Sons, Inc., 1964
- [7] R. Gross, A. Marx, Spinelektronik, www.wmi.badw-muenchen.de/teaching/Lecturenotes/
- [8] P. Bruno, Physical origins and theoretical models of magnetic anisotropy, from Schriften des Forschungszentrums Jülich ISBN 3-89336-110-3, 1993
- [9] M. Getzlaff, Fundamentals of Magnetism, Springer-Verlag Berlin Heidelberg 2008
- [10] P.J. Jensen, K.H. Bennemann, Surface Science Reports **61**, 129 (2006)
- [11] G. Dietz, Die Gestaltungsmagnetostriktion, from Schriften des Forschungszentrums Jülich ISBN 3-89336-110-3, 1993
- [12] J. Nogues, J. Sort, V. Langlais, V. Skumryev, S. Surinach, J.S. Munoz, M.D. Baro, Physics Reports **422**, 65 (2005)